



# 2022

PDU Brochure



# CONTENTS

- 2-10** ● Aluminium Group Socket Strips
- 11-15** ● Desk Type Group Socket Strips
- 16-20** ● Lighting Group
- 21-22** ● Socket Boxes
- 23-25** ● Modular Sockets



- 26** ● IEC Sockets
- 27** ● GST Sockets
- 28** ● Surge Protection Device (SPD)
- 29-30** ● Wireless Charger
- 31-32** ● Multimedia Sockets
- 33-34** ● Faceplates - Connectors - Covers
- 35** ● Overload Protection Devices - Switches
- 36** ● Bluetooth Speaker



## TEM 1U PDU

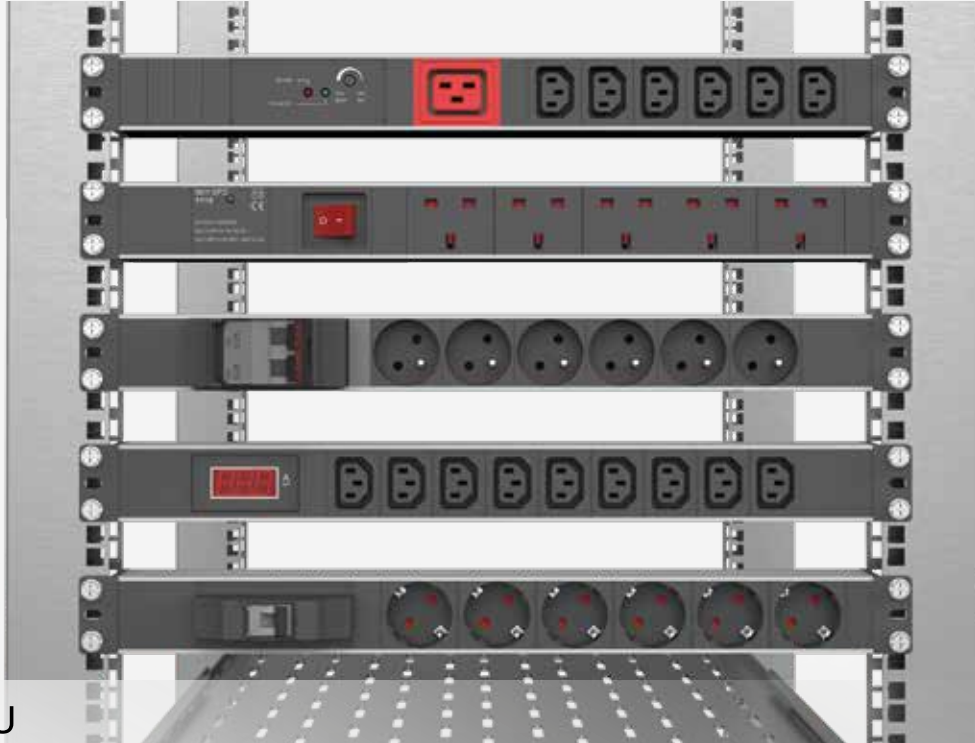

### Standard



### Product Code

- 1400.1070.000
- 19 1400.1080.000
- 1400.1090.000
- 1400.2070.000
- 19 1400.2080.000
- 1400.2090.000

### Description

- 7 Schuko
- 8 Schuko
- 9 Schuko
- 7 Unischuko
- 8 Unischuko
- 9 Unischuko

### SPD



### Product Code

- 1404.1060.000
- 19 1404.1070.000
- 1404.1080.000
- 1404.2060.000
- 19 1404.2070.000
- 1404.2080.000

### Description

- 6 Schuko + SPD
- 7 Schuko + SPD
- 8 Schuko + SPD
- 6 Unischuko + SPD
- 7 Unischuko + SPD
- 8 Unischuko + SPD

### Switch



### Product Code

- 1403.1060.000
- 19 1403.1070.000
- 1403.1080.000
- 1403.2060.000
- 19 1403.2070.000
- 1403.2080.000

### Description

- 6 Schuko + Switch
- 7 Schuko + Switch
- 8 Schuko + Switch
- 6 Unischuko + Switch
- 7 Unischuko + Switch
- 8 Unischuko + Switch

## Single MCB



### Product Code

- 1401.1040.000
- 19 1401.1060.000
- 1401.1080.000
- 1401.2040.000
- 19 1401.2060.000
- 1401.2080.000

### Description

- 4 Schuko + Single MCB
- 6 Schuko + Single MCB
- 8 Schuko + Single MCB
- 4 Unischuko + Single MCB
- 6 Unischuko + Single MCB
- 8 Unischuko + Single MCB

## Double MCB



### Product Code

- 1411.1040.000
- 19 1411.1060.000
- 1411.1080.000
- 1411.2040.000
- 19 1411.2060.000
- 1411.2080.000

### Description

- 4 Schuko + Double MCB
- 6 Schuko + Double MCB
- 8 Schuko + Double MCB
- 4 Unischuko + Double MCB
- 6 Unischuko + Double MCB
- 8 Unischuko + Double MCB

## Overload Protection with Button



### Product Code

- 1412.1060.000
- 19 1412.1070.000
- 1412.1080.000
- 1412.2060.000
- 19 1412.2070.000
- 1412.2080.000

### Description

- 6 Schuko + Overload Protection
- 7 Schuko + Overload Protection
- 8 Schuko + Overload Protection
- 6 Unischuko + Overload Protection
- 7 Unischuko + Overload Protection
- 8 Unischuko + Overload Protection

## Overload Protection with Switch



### Product Code

- 1413.1060.000
- 19 1413.1070.000
- 1413.1080.000
- 1413.2060.000
- 19 1413.2070.000
- 1413.2080.000

### Description

- 6 Schuko + Overload Protection with Switch
- 7 Schuko + Overload Protection with Switch
- 8 Schuko + Overload Protection with Switch
- 6 Unischuko + Overload Protection with Switch
- 7 Unischuko + Overload Protection with Switch
- 8 Unischuko + Overload Protection with Switch

## 1U Covers



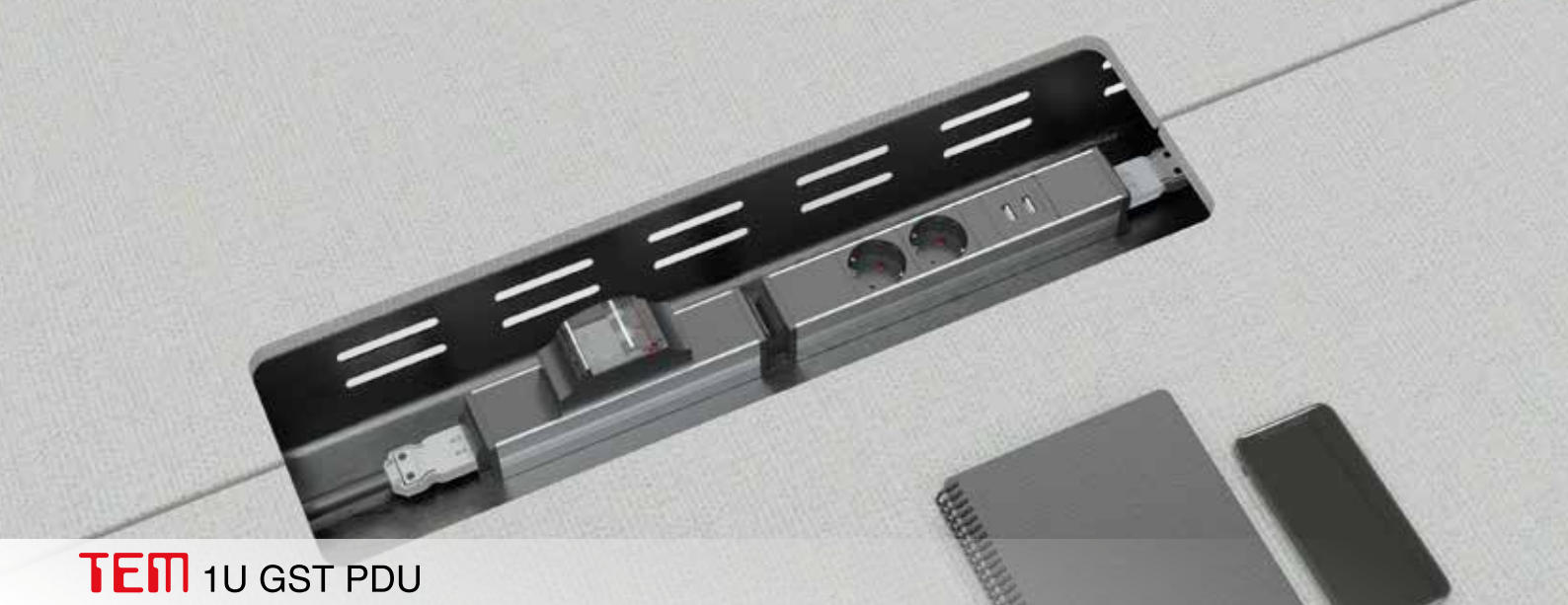

**TEM** 1U GST PDU



1411.0000.003  
Double MCB Module



1414.0000.003  
SPD + EMI-RFI Filter Module



1415.0000.003  
SPD + Switch Module



1400.1020.0202.3  
Double USB Charger + 2 Schuko



1400.1040.003  
4 Schuko



1403.1030.003  
3 Schuko + Switch



725.3150.893  
GST (Female + Male)  
3x1,5 H05VV-F 3m



725.3150.913  
3m GST Female + Unischuko  
3x1,5 H05VV-F 3m



725.3150.933  
3m GST Female + C14  
3x1,5 H05VV-F 3m



## TEM U62 PDU

### Empty Aluminium Housing



### Product Code

### Description

1620.0010.000	10 x 22.5 Module
1620.0012.000	12 x 22.5 Module
1620.0014.000	14 x 22.5 Module
1620.0016.000	16 x 22.5 Module
1620.0018.000	18 x 22.5 Module
1620.0020.000	20 x 22.5 Module

### Product Samples



1620.1232.8711.0  
3 Schuko + 2 Unischuko + 1 Cat6 + 1 Cat3



1620.1222.8722.0  
2 Schuko + 2 Unischuko + 2 Cat6 + 2 Cat3



1620.1222.872111.0  
2 Schuko + 2 Unischuko + 1 Cat6 + 1 Cat3  
+ Double USB Charger



1620.1223.8721.0  
2 Schuko + 3 Unischuko + 2 Cat6 + 1 Cat3



1620.1233.8711.0  
3 Schuko + 3 Unischuko + 1 Cat6 + 1 Cat3



1620.1030.153111.0  
3 Schuko + 1 VGA + 1 HDMI +  
1 USB Charger



## TEM U42 PDU

### Standard



### Product Code

- 1420.1070.000
- ① 1420.1080.000
- 1420.1090.000
- 1420.2070.000
- ① 1420.2080.000
- 1420.2090.000

### Description

- 7 Schuko
- 8 Schuko
- 9 Schuko
- 7 Unischuko
- 8 Unischuko
- 9 Unischuko

### Single MCB



### Product Code

- 1421.1040.000
- ① 1421.1060.000
- 1421.1080.000
- 1421.2040.000
- ① 1421.2060.000
- 1421.2080.000

### Description

- 4 Schuko + Single MCB
- 6 Schuko + Single MCB
- 8 Schuko + Single MCB
- 4 Unischuko + Single MCB
- 6 Unischuko + Single MCB
- 8 Unischuko + Single MCB

### Switch



### Product Code

- 1423.1060.000
- ① 1423.1070.000
- 1423.1080.000
- 1423.2060.000
- ① 1423.2070.000
- 1423.2080.000

### Description

- 6 Schuko + Switch
- 7 Schuko + Switch
- 8 Schuko + Switch
- 6 Unischuko + Switch
- 7 Unischuko + Switch
- 8 Unischuko + Switch



## TEM U42 Product Samples



1420.1223.8721.0  
2 Schuko + 3 Unischuko + 2 Cat6 + 1 Cat3



1420.1233.8711.0  
3 Schuko + 3 Unischuko + 1 Cat6 + 1 Cat3



1420.1232.8711.0  
3 Schuko + 2 Unischuko + 1 Cat6 + 1 Cat3



1420.1222.8722.0  
2 Schuko + 2 Unischuko + 2 Cat6 + 2 Cat3



1422.1050.000  
5 Schuko + Double MCB



1420.1040.110  
4 Schuko + Double USB Charger

## TEM W42 Product Samples



1430.1223.8721.0  
2 Schuko + 3 Unischuko + 2 Cat6 + 1 Cat3



1430.1222.8722.0  
2 Schuko + 2 Unischuko + 2 Cat6 + 2 Cat3



1430.1232.8711.0  
3 Schuko + 2 Unischuko + 1 Cat6 + 1 Cat3



## TEM G70 Desktop PDU

Product Code	Description	a (mm)
--------------	-------------	--------

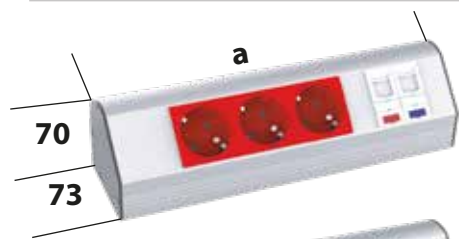

1700.2030.8711.0	3 Unischuko + 1 Cat6 + 1 Cat3	280
------------------	-------------------------------	-----



1700.1222.8711.0	2 Schuko + 2 Unischuko + 1 Cat6 + 1 Cat3	348
------------------	--	-----



1700.2631.8711.0	3 Unischuko + 1 Universal Priz + 1 Cat6 + 1 Cat3	347,5
------------------	--	-------



1700.2030.187111.0	3 Unischuko + 1 Cat6 + 1 Cat3 + 1 USB Charger	302,5
--------------------	---	-------

\* a = Product Length (Side Covers Included)

Mounting Feet	Product Code	Description	a (mm)	b (mm)
---------------	--------------	-------------	--------	--------

	740.050.030	Small Size	$18 \leq a \leq 35$	56
	740.050.070	Big Size	$35 \leq a \leq 75$	96

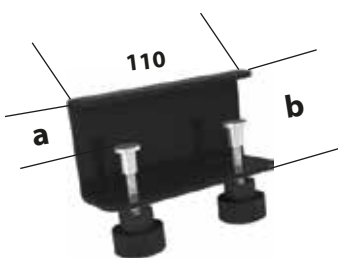

\* a = Table thickness

## Column Housing Models

**U62**

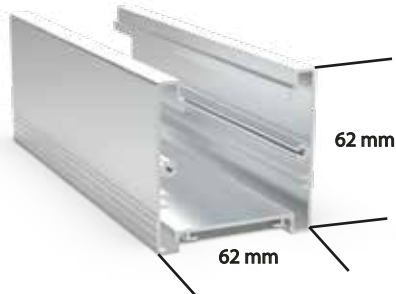

**U62 Double**



**H100**

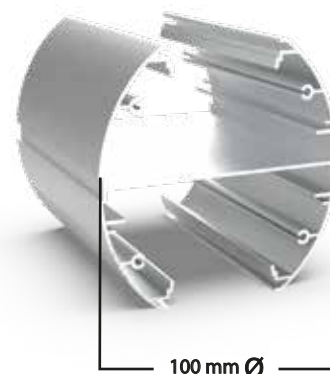

1400.1244.8722.0  
4 Schuko + 4 Unischuko +  
2 Cat6 + 2 Cat3



1400.1040.8142.0  
4 Schuko + 2xDouble USB  
Charger + 4 Cat6



1400.1020.135222.0  
2 Schuko +2 USB Charger +  
2 VGA + 2 HDMI



1400.1040.120  
2 Schuko  
2 USB

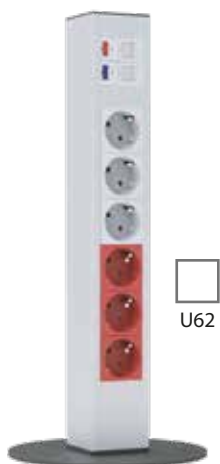

1100.1233.8711.0  
3 Schuko + 3 Unischuko +  
1 Cat 6 + 1 Cat 3



1000.1244.136111.0  
4 Schuko + 4 Unischuko + 2 USB Charger  
+ 2 HDMI + 2 RCA

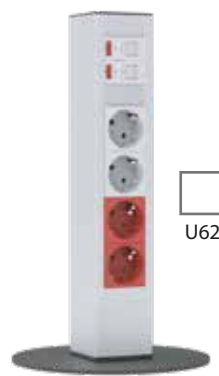

1100.1222.8200.0  
2 Schuko + 2 Unischuko  
2 Cat6



1100.1040.3511.0  
4 Schuko + 1 HDMI  
+ 1 VGA

**TEM**

Column Group

**H100 Mouting Kit**



**H100 Mounting Foot**



**TEM** 044 PDU

	Product Code	Description	a (mm)
	1800.1020.210	2 Schuko + Double USB Charger	232
	1800.2020.210	2 Unischuko + Double USB Charger	232
	1800.1030.000	3 Schuko	205
	1800.2030.000	3 Unischuko	205
	1804.1020.210	2 Schuko + Double USB Charger + Overload Protection	307
	1804.2020.210	2 Unischuko + Double USB Charger + Overload Protection	307
	1804.1030.000	3 Schuko + Overload Protection	280
	1804.2030.000	3 Unischuko + Overload Protection	280

Table Cutting Dimensions  $\varnothing$ 60mm  
Provides free up space when not using  
Special Locking Mechanism





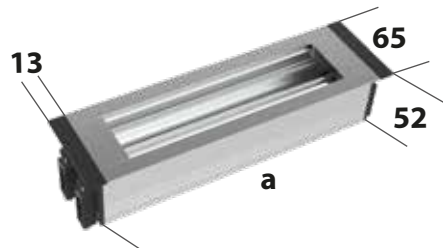

## TEM Power Frame

Empty Aluminium Housing	Product Code	Description	Cutting Dimensions	
			a+7(mm)	a (mm)
	1720.0010.000	10 x 22,5 Module	232 x 55	225
	1720.0012.000	12 x 22,5 Module	277 x 55	270
	1720.0014.000	14 x 22,5 Module	322 x 55	315
	1720.0016.000	16 x 22,5 Module	367 x 55	360



\* **a** = Aluminium length without side covers  
**a+26** = Total Product Length

	Product Code	Description	Cutting Dimensions	
			a+6(mm)	a (mm)
	1720.1020.110	2 Schuko + USB Charger	208,5 x 55	202,5
	1720.2030.8711.0	3 Unischuko + 1 Cat6 + 1 Cat3	276 x 55	270
	1720.4020.1511.0	2 British Socket + 1 USB Charger + VGA	243 x 55	225
	1720.1222.0802.0	2 Schuko + 2 Unischuko + 2 Cat6	343,5 x 55	337,5



**TEM** Cable Grommet

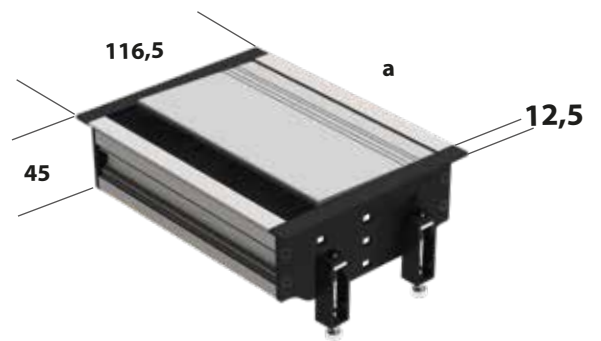
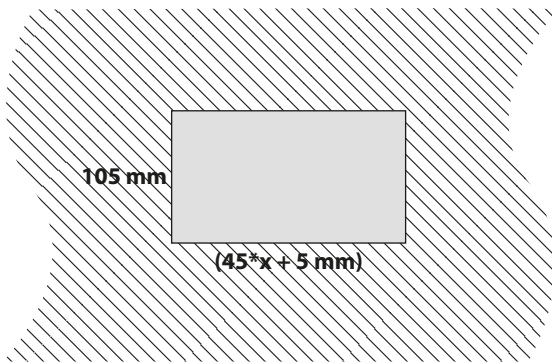

Empty Aluminium Housing



Product Code

Description

Cutting Dimensions

			a+7(mm)	a (mm)
1710.0010.000	10 x 22,5 Module		232 x 105	225
1710.0012.000	12 x 22,5 Module		277 x 105	270
1710.0014.000	14 x 22,5 Module		322 x 105	315
1710.0016.000	16 x 22,5 Module		367 x 105	360

\* **a** = Aluminium length without side covers  
**a+25** = Total Product Length

## TEM Flip Power Frame



### Empty Aluminium Housing

### Product Code

### Description

### Cutting Dimensions

a+35(mm)

(mm)<sup>a</sup>

1730.0010.0

10 x 22,5 Module

260 x 105

225

1730.0012.0

12 x 22,5 Module

305 x 105

270

1730.0014.0

14 x 22,5 Module

350 x 105

315

1730.0016.0

16 x 22,5 Module

395 x 105

360

\* a = Aluminium length without side covers

a+56 = Total Product Length

### Product Samples

### Product Code

### Description

### Cutting Dimensions

a+35(mm)

(mm)<sup>a</sup>

1730.1020.110

2 Schuko + 1 USB Charger

260 x 105

225

1730.1020.8711.0

2 Schuko + 1 Cat6 + 1 Cat3

237,5 x 105

202,5

1730.1222.8711.0

2 Schuko + 2 Unischuko + 1 Cat6  
+ 1 Cat3

372,5 x 105

337,5

1730.1631.210

3 Schuko + 1 Universal Socket  
+Double USB Charger

395 x 105

360

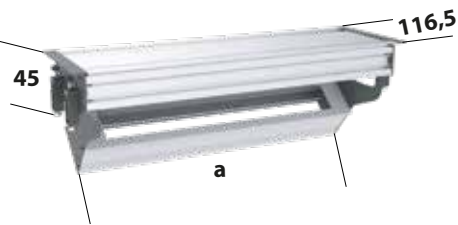





## TEM Horizontal Desk Socket Strip

Empty Aluminium Housing	Product Code	Description	Cutting Dimensions	
			a+70(mm)	a (mm)
	1740.0010.0	10 x 22,5 Module	295 x 135	225
	1740.0012.0	12 x 22,5 Module	340 x 135	270
	1740.0014.0	14 x 22,5 Module	385 x 135	315
	1740.0016.0	16 x 22,5 Module	430 x 135	360

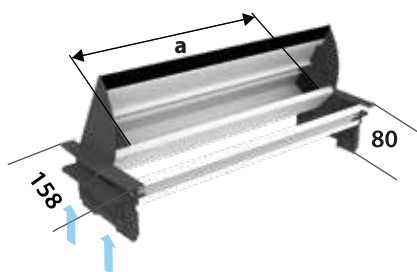

\* a = Empty space in housing  
**a+70** = Product Cutting Dimensions  
**a+100** = Total Product Length

Product Samples	Product Code	Description	Cutting Dimensions	
			a+35(mm)	a (mm)
	1740.1040.820	4 Schuko + 2 Cat6	362,5x135	292,5
	1740.1222.8711.0	2 Schuko + 2 Unischuko + 1 Cat6 +1 Cat3	385x135	315
	1740.1224.842	2 Schuko + 4 Unischuko + 4 Cat6 + Socket Input	520x135	450
	1740.1233.840	3 Schuko + 3 Unischuko + 4 Cat6	520x135	450



Control Options

- PIR Movement Sensor
- IR Movement Sensor
- Door Sensor
- Touch ON-OFF Switch
- 3 Phase Dimmer
- On / Off Switch

## TEM Lighting

- Light Color: 6500 K / 3000 K
- Input: 220 V With Driver 100/200 V AC  
220 V Without Driver 220 V AC  
24 V Without Driver 24 V AC
- Mounting: Rack  
Screw  
Magnet

### Standard



	Product Code	Description
<b>220 V Without Driver</b>	1405.1.0030.X1	35cm 14W 1m Cable
	1405.1.0050.X1	55cm 18W 1m Cable
<b>220 V With Driver</b>	1405.2.0030.X1	35cm 8,4W 1m Cable
	1405.2.0050.X1	55cm 14W 1m Cable
<b>24 V Without Driver</b>	1405.4.0030.X1	35cm 8,4W 1m Cable
	1405.4.0050.X1	55cm 14W 1m Cable

X = 0 Without Magnet

X = 1 With Magnet

## ON-OFF Switch



**220 V  
Without Driver**

Product Code

1405.1.0130.X1

Description

35cm 14W 1m Cable

1405.1.0150.X1

55cm 18W 1m Cable

**220 V  
With Driver**

1405.2.0130.X1

35cm 8,4W 1m Cable

1405.2.0150.X1

55cm 14W 1m Cable

**24 V  
Without Driver**

1405.4.0130.X1

35cm 8,4W 1m Cable

1405.4.0150.X1

55cm 14W 1m Cable

X = 0 Without Magnet

X = 1 With Magnet

## Touch ON-OFF Switch



**220 V  
Without Driver**

Product Code

1405.1.0230.X1

Description

35cm 14W 1m Cable

**220 V  
With Driver**

1405.2.0230.X1

35cm 8,4W 1m Cable

1405.2.0250.X1

55cm 14W 1m Cable

**24 V  
Without Driver**

1405.4.0230.X1

35cm 8,4W 1m Cable

1405.4.0250.X1

55cm 14W 1m Cable

X = 0 Without Magnet

X = 1 With Magnet

## PIR Movement Sensor



**220 V  
Without Driver**

Product Code

1405.1.0330.X1

Description

35cm 14W 1m Cable

1405.1.0350.X1

55cm 18W 1m Cable

**220 V  
With Driver**

1405.2.0330.X1

35cm 8,4W 1m Cable

1405.2.0350.X1

55cm 14W 1m Cable

**24 V  
Without Driver**

1405.4.0330.X1

35cm 8,4W 1m Cable

1405.4.0350.X1

55cm 14W 1m Cable

X = 0 Without Magnet

X = 1 With Magnet



### Door Sensor

**220 V  
With Driver**  
**24 V  
Without Driver**

#### Product Code

1405.2.0430.X1  
1405.2.0450.X1  
1405.4.0430.X1  
1405.4.0450.X1

#### Description

35cm 8,4W 1m Cable  
55cm 14W 1m Cable  
35cm 8,4W 1m Cable  
55cm 14W 1m Cable

X = 0 Without Magnet  
X = 1 With Magnet



### 3 Phase Dimmer

**220 V  
With Driver**  
**24 V  
Without Driver**

#### Product Code

1405.2.0630.X1  
1405.2.0650.X1  
1405.4.0630.X1  
1405.4.0650.X1

#### Description

35cm 8,4W 1m Cable  
55cm 14W 1m Cable  
35cm 8,4W 1m Cable  
55cm 14W 1m Cable

X = 0 Without Magnet  
X = 1 With Magnet



### IR Movement Sensor

**220 V  
With Driver**  
**24 V  
Without Driver**

#### Product Code

1405.2.0530.X1  
1405.2.0550.X1  
1405.4.0530.X1  
1405.4.0550.X1

#### Description

35cm 8,4W 1m Cable  
55cm 14W 1m Cable  
35cm 8,4W 1m Cable  
55cm 14W 1m Cable

X = 0 Without Magnet  
X = 1 With Magnet



### U20 Lightning

**220 V**  
**24V**

#### Product Code

120X.243.04.36  
120X.245.07.60  
120X.2410.14.120  
120X.223.05.40  
120X.224.06.48  
120X.225.10.80  
120X.242.04.36

#### Description

220V 1m Cable + 35cm 5W  
220V 1m Cable + 41cm 6W  
220V 1m Cable + 52cm 10W  
24V 1m Cable + 20cm 4.3W  
24V 1m Cable + 30cm 4.3W  
24V 1m Cable + 50cm 7.2W  
24V 1m Cable + 100cm 14.1W

X = 0 Without Magnet  
X = 1 With Magnet



## TEM Linear Armature

● Light Color: 6500 K / 3000 K

● Input: 220 V With Driver 100/200 V AC  
24 V Without Driver 24 V AC

● Mounting: Rack,  
Screw,  
Magnet

### Type 1U

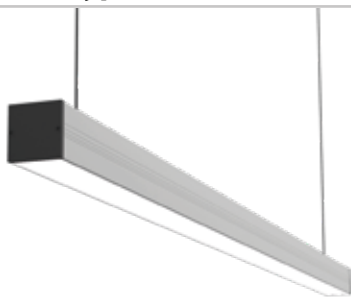

**220 V  
With Driver**

Product Code

Description

14025.2.0060 60cm 16,8W  
14025.2.0090 90cm 25,2W  
14025.2.00120 120cm 33,6W  
14025.2.00150 150cm 42W

**24 V**

14025.4.0060 60cm 16,8W  
14025.4.0090 90cm 25,2W  
14025.4.00120 120cm 33,6W  
14025.4.00150 150cm 42W

### Type C

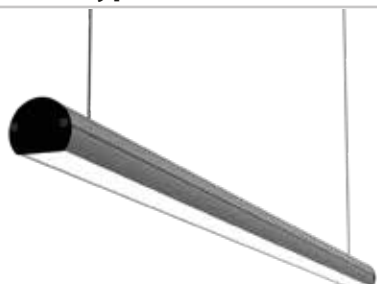

**220 V  
With Driver**

Product Code

Description

14425.2.0060 60cm 16,8W  
14425.2.0090 90cm 25,2W  
14425.2.00120 120cm 33,6W  
14425.2.00150 150cm 42W

**24 V**

14425.4.0060 60cm 16,8W  
14425.4.0090 90cm 25,2W  
14425.4.00120 120cm 33,6W  
14425.4.00150 150cm 42W

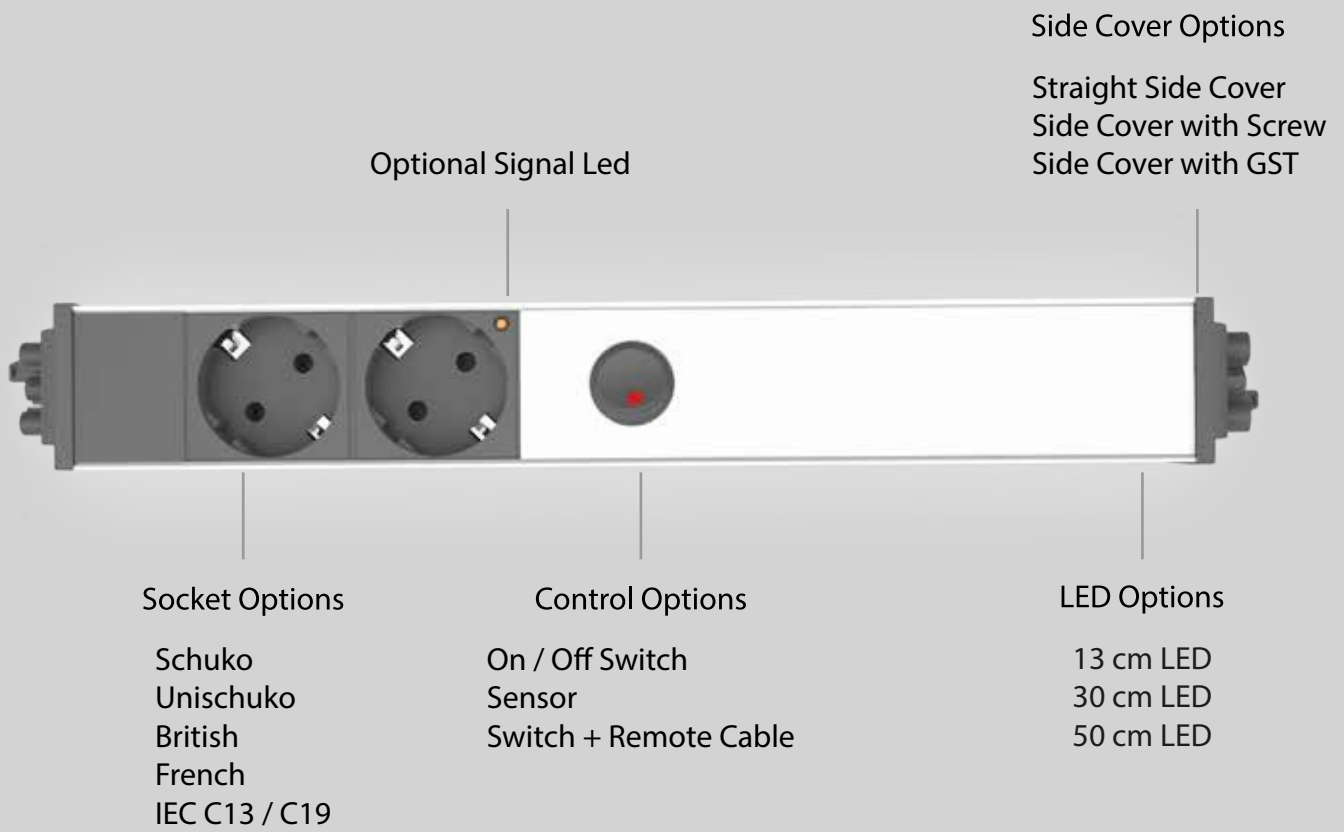

## TEM Socket Lightning

● Light Color: 6500 K / 3000 K

● Input: 220 V With Driver 100/200 V AC  
24 V Without Driver 220 V AC

● Mounting: Rack, Magnet

### Type 1U



**220 V  
Without Driver**

Product Code	Description
1405.1013.1020.X0	2 Schuko + 13cm LED + 3m Cable
1405.1013.2020.X0	2 Unischuko + 13cm LED + 3m Cable
1405.1030.1020.X0	2 Schuko + 30cm LED + 3m Cable
1405.1030.2020.X0	2 Unischuko + 30cm LED + 3m Cable
1405.2030.1020.X0	2 Schuko + 30cm LED + 3m Cable
1405.2030.2020.X0	2 Unischuko + 30cm LED + 3m Cable

**220 V  
With Driver**

X = 0 Without Magnet  
X = 1 With Magnet

### Type G70







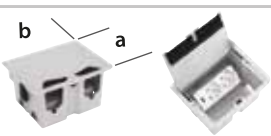

**220 V  
Without Driver**

Product Code	Description
1705.1030.1020.X0	2 Schuko + 30cm LED + Without Cable
1705.1030.1040.X0	4 Schuko + 30cm LED + Without Cable
1705.1050.1020.X0	2 Schuko + 50cm LED + Without Cable
1705.1050.1040.X0	4 Schuko + 50cm LED + Without Cable
1705.2030.1020.X0	2 Schuko + 30cm LED + Without Cable
1705.2030.1040.X0	4 Schuko + 30cm LED + Without Cable
1705.2050.1020.X0	2 Schuko + 50cm LED + Without Cable
1705.2050.1040.X0	4 Schuko + 50cm LED + Without Cable

**220 V  
With Driver**

## TEM Plastic Body Table Groups

	Product Code	Description	Module	Table Cut Dimensions	
				a	b
	800.025.02X	Socket Box (With Brush-Grey, Black, White)	2.5x45	126	175
	800.025.022	Socket Box (Metallic Coating)			
	800.025.12X	Socket Box (With Brush-Grey, Black, White)	2.5x45	80	170
	800.025.122	Socket Box (Metallic Coating)			
	800.045.02X	Socket Box (With Brush-Grey, Black)	4.5x45	127	253
	800.045.022	Socket Box (With Brush - Metallic Coating)			
	800.045.12X	Socket Box (With Brush-Grey, Black)	4.5x45	127	253
	800.045.122	Socket Box (With Brush - Metallic Coating)			
	800.050.02X	Socket Box (With Brush-Grey, Black, White)	5x45	126	175
	800.050.022	Socket Box (Metallic Coating)			
	800.090.02X	Socket Box (With Brush-Grey, Black)	9x45	127	253
	800.090.022	Socket Box (With Brush - Metallic Coating)			

X = 1 Grey
X = 3 Black
X = 6 White

## TEM Aluminium Body Table Groups

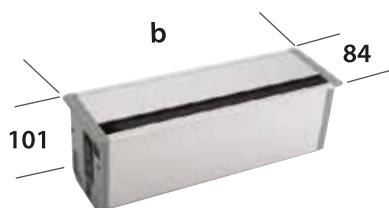

Product Code	Module	b
810.020.01X	2x45	132
810.030.01X	3x45	171
810.040.01X	4x45	238
810.050.01X	5x45	279
810.060.01X	6x45	342
810.070.01X	7x45	387
810.080.01X	8x45	449
810.090.01X	9x45	474
810.0100.01X	10x45	534

X = 1 Anodized
X = 3 Black
X = 6 White

All dimensions are based on "mm"

Underfloor Enclosure

Underfloor Socket Box (Empty)  
Capacity 18 pcs 22.5 Module

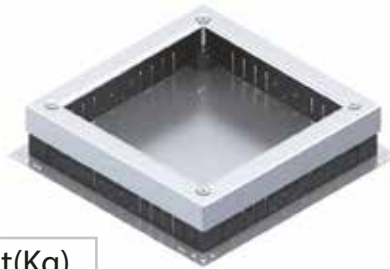

Product Code	Dimension(mm)	Weight(Kg)
205.352.000	352x352	2.563
206.252.000	252x252	1.461

113x210mm  
Surface Socket Boxes



210.0000.0000  
113x210x70mm



210.1200.4400  
4 Schuko + 4 Unischuko



212.1000.6000  
6 Schuko + 2 MCB Slot

210x280mm  
Surface Socket Boxes



280.0000.0000  
210x280x70mm



280.1200.6600  
6 Schuko + 6 Unischuko



282.1200.6300  
6 Schuko + 3 Unischuko + 2 MCB Slot







250.216.150  
Screwed Schuko Socket 45°



250.316.150  
Screwed UPS Socket 45°



245.216.150  
Toolless Single Terminal  
Schuko Socket



245.316.150  
Toolless Single Terminal  
UPS Socket



246.216.150  
Toolless Single Terminal  
Schuko Socket 45°



246.316.150  
Toolless Single Terminal  
UPS Socket 45°



345.216.150  
Toolless Double Terminal  
Schuko Socket



345.316.150  
Toolless Double Terminal  
UPS Socket



346.216.150  
Toolless Double Terminal  
Schuko Socket 45°



346.316.150  
Toolless Double Terminal  
UPS Socket 45°



247.216.150  
Toolless Single Terminal  
French Socket 45°



347.216.151  
Toolless Single Terminal  
French Socket

**Sockets with Cover**



Sided Toolless option,  
It is suitable horizontal and  
vertical uses.



350.216.160  
Sided Toolless Double Terminal  
with Cover Schuko Socket



350.316.160  
Sided Toolless Double Terminal  
with Cover UPS Socket

# TEM Modular Sockets

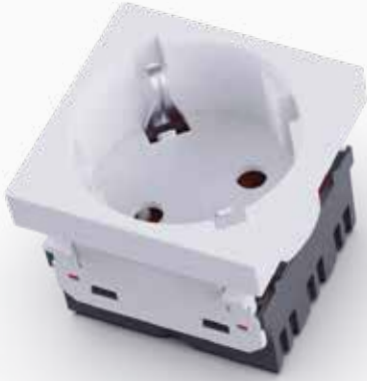

350.216.150  
Sided Toolless Double Terminal  
Schuko Socket 45°



740.061.002  
Socket Mounting Tool



350.316.150  
Sided Toolless Double Terminal  
UPS Prizi 45°



# TEM Universal Plugs & Sockets



721.170.150  
45x45mm Universal Socket



721.160.150  
45x45mm USA Socket



721.130.150  
45x45mm British Socket



721.130.151  
51x45mm British Socket



721.130.300  
British Plug



**SCHUKO TYPE**

16A 2P+E 200-250 V~



	Description	Code	Child Protected Code
Cable	2 Schuko Socket	310.002.003	310.002.103
	3 Schuko Socket	310.003.003	310.003.103
	4 Schuko Socket	310.004.003	310.004.103
Terminal	2 Schuko Socket	311.002.003	311.002.103
	3 Schuko Socket	311.003.003	311.003.103
	4 Schuko Socket	311.004.003	311.004.103
Double Terminal	2 Schuko Socket	312.002.003	312.002.103
	3 Schuko Socket	312.003.003	312.003.103
	4 Schuko Socket	312.004.003	312.004.103

**UPS TYPE**

16A 2P+E 200-250 V~

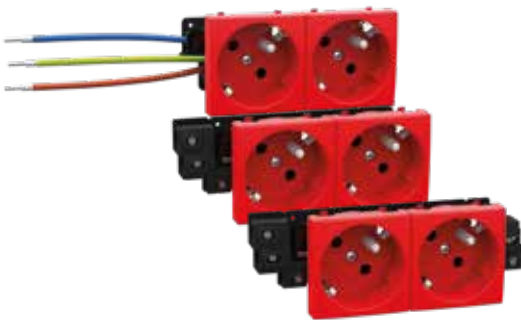

	Description	Code	Child Protected Code
Cable	2 UPS Socket	320.002.002	320.002.102
	3 UPS Socket	320.003.002	320.003.102
	4 UPS Socket	320.004.002	320.004.102
Terminal	2 UPS Socket	321.002.002	321.002.102
	3 UPS Socket	321.003.002	321.003.102
	4 UPS Socket	321.004.002	321.004.102
Double Terminal	2 UPS Socket	322.002.002	322.002.102
	3 UPS Socket	322.003.002	322.003.102
	4 UPS Socket	322.004.002	322.004.102

**FRENCH TYPE**

16A 2P+E 200-250 V~



	Description	Code
Cable	2 French Socket	350.002.102
	3 French Socket	350.003.102
	4 French Socket	350.004.102
Terminal	2 French Socket	351.002.102
	3 French Socket	351.003.102
	4 French Socket	351.004.102
Double Terminal	2 French Socket	352.002.102
	3 French Socket	352.003.102
	4 French Socket	352.004.102

**IEC TYPE SOCKET 10A 2P+E 200-250 V~**



Description	Code
2 IEC Socket	330.002.004
3 IEC Socket	330.003.004
4 IEC Socket	330.004.004

**BRITISH TYPE 13A 2P+E 200-250 V~**

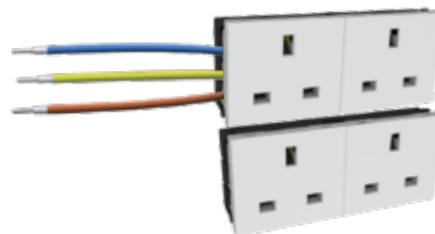

	Description	Code
Cable	2 British Socket	340.002.003
	3 British Socket	340.003.003
	4 British Socket	340.004.003
Double Terminal	2 British Socket	342.002.003
	3 British Socket	342.003.003
	4 British Socket	342.004.003



720.130.150  
IEC C13 10A  
Toolless Socket



720.130.160  
IEC C13 10A  
Screwed Socket



720.130.200  
IEC C13 10A  
Movable Socket



720.140.320  
IEC C14 10A  
Toolless Plug



720.140.340  
IEC C14 10A  
Screwed Plug



720.140.300  
IEC C14 10A  
Movable Plug



720.140.321  
IEC C14 10A  
Plug



720.190.150  
IEC C19 16A  
Toolless Socket



720.190.160  
IEC C19 16A  
Screwed Socket



720.190.200  
IEC C19 16A  
Movable Socket



720.200.320  
IEC C20 16A  
Toolless Plug



720.240.340  
IEC C20 16A  
Screwed Plug



720.200.300  
IEC C20 16A  
Movable Plug



720.200.321  
IEC C20 16A  
Plug



724.021.000  
Movable GST Socket  
Female / Male



724.011.000  
Movable GST Socket  
Female / Male



724.020.000  
GST Female Socket



724.010.000  
GST Male Socket

724.000.010  
Plastic Lock



## 2.5mm<sup>2</sup> Socket Terminals



720.400.200 - White  
720.400.201 - Black  
720.400.202 - Red  
Male - Female Socket Group



720.500.002  
2 Terminal



720.500.003  
3 Terminal



720.500.004  
4 Terminal



720.500.005  
5 Terminal

## tem SPD 0120 Type 3 Surge Protection

$U_c$  : 255V - 50-60 Hz

$U_{oc}$  : 5/10 kV

$I_n$  : 2,5/5 kA

$U_p$  :  $\leq 1,5$  kV



  
22.5x45mm  
734.612.0120.X  
SPD 0120-1(Black - White)

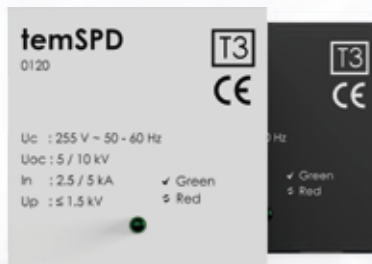

  
45x45mm  
734.613.0120.X  
SPD 0120-1(Black - White)

**Not:** If the indicator light on the product is green, the product is working normally, and if it is red, the product must be replaced.

X = 0 White

X = 1 Black

## tem SPD 1119 Type 3 Surge Protection

$U_c$  : 255V - 50-60 Hz

$U_{oc}$  : 5 kV

$I_n$  : 3 kA

$U_p$  :  $\leq 2$  kV



  
45x45mm  
734.613.1119.X  
SPD 0120-1(Black - White)

## tem SPD 1119-N Type 3 Surge Protection

$U_c$  : 255V - 50-60 Hz

$U_{oc}$  : 5 kV

$U_p$  : 3 kA

$I_n$  :  $\leq 2$  kV



  
45x45mm  
734.613.1119.XN  
SPD 0120-1(Black - White)

**Note:** If the indicator light on the product is green, the product is working normally, and if it is red, the product must be replaced.

**Parasite Filter:** Protects sensitive electronic devices such as computers, telephones and stereos from high-frequency interference voltages. Thus, the noise in the screen and sound is effectively suppressed.

X = 0 White

X = 1 Black



## TEM Wireless Charger



### Code

715.200.13X

### USB

5V 2.1A 10,5 W

### Without Cable

5V 5 W - 7,5 W

### Transmission Range

≤ 8mm  
( Recommend: 2mm-4mm )

### Performance

≥ 73%

### Standard

Qi

Stylish and functional design.

Indicates charging status with LED power indicator light.

It keeps your phone safe with its non-slip surface.

Compatible with cases up to 3mm thick.

Ability to use USB port and Wireless charging at the same time.

Over Temperature and Current protection

It supports up to 7.5W fast wireless charging for your devices.

Object Detection (FOOD) Feature.

## Color

X = 1 Black 

X = 2 Grey 



715.200.12X  
TYPE A/C - 30W(max)  
45x45mm (Black - White)

X = 0 White

X = 1 Black

**22.5x45mm USB Chargers**



715.200.20X  
TYPE A - 2.1A  
22.5x45mm (Black - White)



715.200.11X  
TYPE A - 2 A  
22.5x45mm (Black - White)



715.200.10X  
TYPE A - 1 A  
22.5x45mm (Black - White)

X = 0 White

X = 1 Black

**45x45mm USB Chargers**



715.100.10X  
TYPE A/C - 2.1 A  
45x45mm (Black - White)



715.100.11X  
TYPE A/A - 2.1 A  
45x45mm (Black - White)

X = 0 White

X = 1 Black



**45x45mm TV Connectors**



723.000.150  
TV Socket



723.000.300  
TV Socket Male  $\varnothing$ 9.52mm



723.000.400  
TV Receiver Socket

**VGA Connectors**



715.300.001  
6+2 Terminal Input  
22.5x45mm - Faceplate



715.300.002  
14+2 Terminal Input 22.5x45mm  
Fast Mount - Faceplate



715.300.003  
Socket Input  
45x45mm - Faceplate



715.300.004  
Socket Input  
22.5x45mm - Faceplate



715.300.005  
15 Terminal Input  
22.5x45mm - Faceplate



715.300.007  
9 Pins  
22.5x45mm Faceplate



715.300.009  
B Socket Input  
45x45mm - Faceplate

**RCA & STEREO Connectors**



715.500.002  
RCA Connector 22.5x45mm  
Terminal - Faceplate



715.500.001  
RCA Connector 22.5x45mm  
Terminal - Faceplate



715.600.001  
Stereo Connector 22.5x45mm  
Terminal - Faceplate

**HDMI Connectors**



715.400.001  
TYPE A Female - Female 90°  
22.5x45mm - Faceplate



715.400.002  
TYPE A Female - Female 180°  
22.5x45mm - Faceplate



715.400.003  
TYPE A Female - Female Top  
Input - Output 22.5x45mm - Faceplate

**HDMI Connector**



715.400.008  
HDMI Connector TYPE A Female-Female  
45x45mm - Faceplate

**DISPLAY Connector**



715.700.001  
Display Port Connector Soket Input  
45x45mm - Faceplate

**XLR Connector**



715.600.002  
XLR Female Soket  
45x45mm Terminal - Faceplate

**USB Connectors**



715.200.004  
Standart A  
USB AF/AF 90°  
22.5x45mm - Faceplate



715.200.005  
Standart A  
USB AF/AF 180°  
22.5x45mm - Faceplate



715.200.006  
Standart A  
Terminal  
22.5x45mm - Faceplate

**USB / HDMI Keystone**



715.200.001  
Standart B  
Female - Female  
Keystone



715.200.002  
Standart A  
Female - Female  
Keystone



715.200.003  
Standart A  
Female - Female Cable  
Keystone



715.400.004  
TYPE A Female  
Female  
Keystone



715.400.005  
TYPE A Female  
Female  
Cable Keystone



710.100.103  
45x45mm with String and Cover



710.100.104  
22x45mm with String Cover



710.100.105  
45x45mm with String and Cover - Double



**Telefon -Data Connectors**

**Female - Female Telefon - Data Connectors**



715.100.030  
CAT3 TELEPHONE



715.100.050  
CAT5E DATA



715.100.060  
CAT6 DATA



715.100.061  
CAT6A DATA



715.200.030  
CAT3 TELEPHONE



715.200.050  
CAT5E DATA



715.200.060  
CAT6 DATA

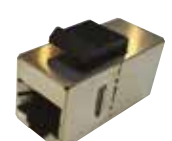

715.200.061  
CAT6A DATA



**Telephone Data Plugs**



710.100.350  
CAT5 DATA Plug



710.100.360  
CAT6 DATA Plug



710.100.332 - 2 PINS  
710.100.334 - 4 PINS  
710.100.336 - 6 PINS  
Telephone Plug



# TEM Underfloor / Gap Faceplates



708.100.010  
50x50mm - Single



708.100.020  
50x50mm - Double



709.100.103  
45x45mm



709.100.104  
22.5x45mm



## Telephone - Data Faceplates



710.100.107  
45x45mm without Cover - Double



710.100.111  
22.5x45mm without Cover - Single



710.100.106  
45x45mm without Cover - Single



709.200.104  
22x45mm



709.200.103  
45x45mm



709.200.105  
45x90mm

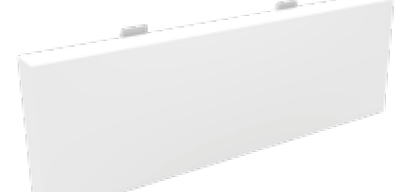

709.200.106  
45x135mm



## 45x45mm Keystone Faceplates



710.100.108  
Lift-up Faceplate



710.100.109  
Keystone - Faceplate - Single



710.100.110  
Keystone - Faceplate - Double



# tem Overload Protection

Current : 16A  
 Voltage : 125/250 V AC  
 Insulation Resistance : >100MOHM (DC 500V)  
 IP Degree : IP40



723.225.016  
 Overload Protection with Button  
 22.5x45mm



723.225.116  
 Overload Protection with Switch  
 22.5x45mm

## On - Off Switches



722.045.012  
 Single Switch 16A  
 45x45mm  
 without Light

722.045.112  
 Single Switch 16A  
 45x45mm  
 with Light



722.045.011  
 Double Switch  
 2x10A 45x45mm  
 without Light

722.045.111  
 Double Switch  
 2x10A 45x45mm  
 with Light



722.225.010  
 Switch 10A  
 22.5x45mm  
 without Light

722.225.110  
 Switch 10A  
 22.5x45mm  
 with Light



722.225.021  
 Switch 16A  
 22.5x45mm  
 without Light



722.045.022  
 Double Switch 2x16A  
 45x45mm  
 without Light



722.225.112  
 Switch 16A  
 22.5x45mm  
 with Light



722.045.122  
 Double Switch 2x16A  
 45x45mm  
 with Light



## Bluetooth 5.0

 Android - IOS Compatible

 Signal Noise Ratio: 95DB

 Operating Temperature: 10 - 40 °C

 Operating Humidity: 35 ~ 85%

 Communication Distance: 10m

 Frequency Response: 120Hz - 18KHz

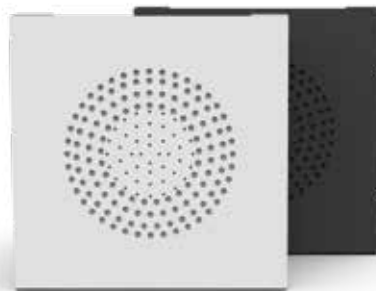

715.200.12X  
240V AC / 50-60Hz 0.3A  
45x45mm (Black - White)

X = 3 White

X = 4 Black

## Product Samples



1620.1200.11101  
2 Schuko + 2 USB Charger  
+ Bluetooth Speaker + 450cm Housing



1620.1200.1182101  
2 Schuko + 2 Cat6 + 2 USB Charger  
+ Bluetooth Speaker + 500cm Housing



1620.1300.11101  
3 Schuko + 2 USB Charger  
+ Bluetooth Speaker + 550cm Housing







# TEM®

**TEM TEKNİK ELEKTRİK MALZEMELERİ SANAYİ VE TİCARET ANONİM ŞİRKETİ**

 Selimpaşa Ortaköy Sanayi Bölgesi, İtler Bulvarı, Mor Menekşe Sok, No:5 34590  
SİLİVRİ / İSTANBUL / TÜRKİYE

 +90 212 485 19 00

 +90 212 485 15 33

 [www.temteknik.com](http://www.temteknik.com)

 [info@temteknik.com](mailto:info@temteknik.com)