

TEM®



BS CATALOG
2021

CONTENTS

- 2-9 ● Aluminum Group Sockets
- 10 ● Wireless Charger
- 11-17 ● Desk Type Sockets
- 18 ● Sockets Boxes



- 19-20 ● Under Floor / Cable Trunking Sockets
- 21-22 ● Multimedia Sockets
- 23-25 ● Faceplate - Connectors



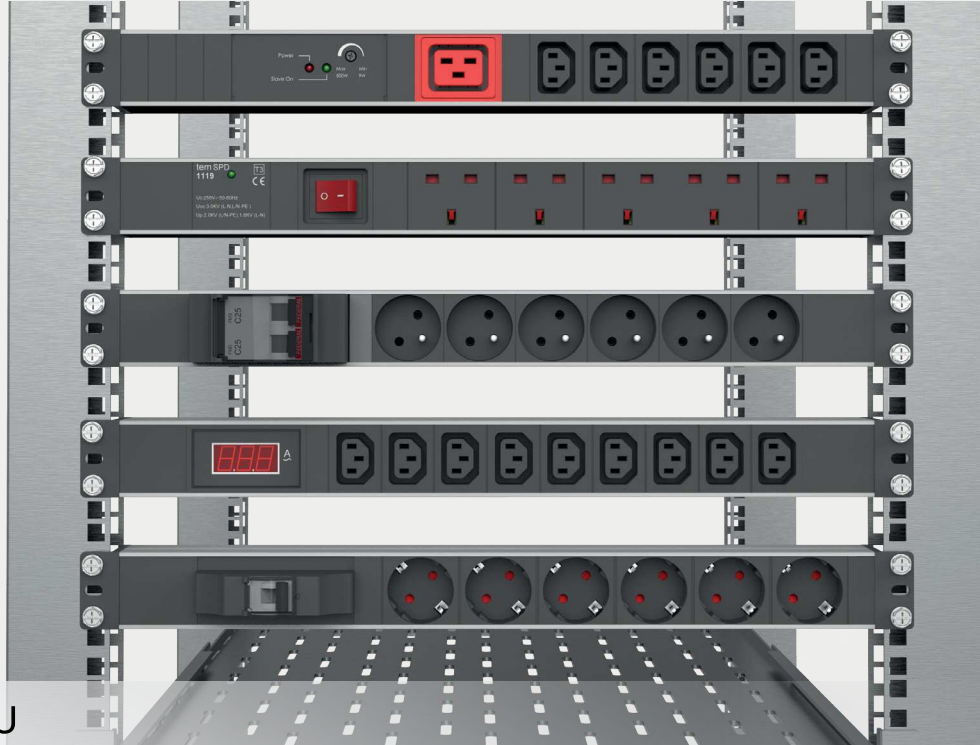

Basic



Code

- ① 4000.4070.000
- 4000.4080.000
- 4000.4090.000
- 4000.1070.000
- ① 4000.1080.000
- 4000.1090.000

Description

- ⚠ 7 BS Sockets
- ⚠ 8 BS Sockets
- ⚠ 9 BS Sockets
- ⦿ 7 Schuko Sockets
- ⦿ 8 Schuko Sockets
- ⦿ 9 Schuko Sockets

SPD



Code

- ① 4004.4060.000
- 4004.4070.000
- 4004.4080.000
- 4004.1060.000
- ① 4004.1070.000
- 4004.1080.000

Description

- ⚠ 6 BS Sockets + SPD
- ⚠ 7 BS Sockets + SPD
- ⚠ 8 BS Sockets + SPD
- ⦿ 6 Schuko Sockets + SPD
- ⦿ 7 Schuko Sockets + SPD
- ⦿ 8 Schuko Sockets + SPD

Switch



Code

- ① 4003.4060.000
- 4003.4070.000
- 4003.4080.000
- 4003.1060.000
- ① 4003.1070.000
- 4003.1080.000

Description

- ⚠ 6 BS Sockets + Switch
- ⚠ 7 BS Sockets + Switch
- ⚠ 8 BS Sockets + Switch
- ⦿ 6 Schuko Sockets + Switch
- ⦿ 7 Schuko Sockets + Switch
- ⦿ 8 Schuko Sockets + Switch

MCB



Code

- 19 4001.4050.000
- 4001.4060.000
- 4001.4070.000
- 4001.1040.000
- 19 4001.1060.000
- 4001.1080.000

Description

- 5 BS Sockets + MCB
- 6 BS Sockets + MCB
- 7 BS Sockets + MCB
- 4 Schuko Sockets + MCB
- 6 Schuko Sockets + MCB
- 8 Schuko Sockets + MCB

Leakage Current



Code

- 19 4011.4050.000
- 4011.4060.000
- 4011.4070.000
- 4011.1040.000
- 19 4011.1060.000
- 4011.1080.000

Description

- 5 BS Sockets + Leakage Current
- 6 BS Sockets + Leakage Current
- 7 BS Sockets + Leakage Current
- 4 Schuko Sockets + Leakage Current
- 6 Schuko Sockets + Leakage Current
- 8 Schuko Sockets + Leakage Current

Overload Protector



Code

- 19 4012.4060.000
- 4012.4070.000
- 4012.4080.000
- 4012.1060.000
- 19 4012.1070.000
- 4012.1080.000

Description

- 6 BS Sockets + Current Protection
- 7 BS Sockets + Current Protection
- 8 BS Sockets + Current Protection
- 6 Schuko Sockets + Current Protection
- 7 Schuko Sockets + Current Protection
- 8 Schuko Sockets + Current Protection

Switch Overload Protector



Code

- 19 4013.4060.000
- 4013.4070.000
- 4013.4080.000
- 4013.1060.000
- 19 4013.1070.000
- 4013.1080.000

Description

- 6 BS Sockets + Switch Current Protection
- 7 BS Sockets + Switch Current Protection
- 8 BS Sockets + Switch Current Protection
- 6 Schuko Sockets + Switch Current Protection
- 7 Schuko Sockets + Switch Current Protection
- 8 Schuko Sockets + Switch Current Protection

1U Cover Models

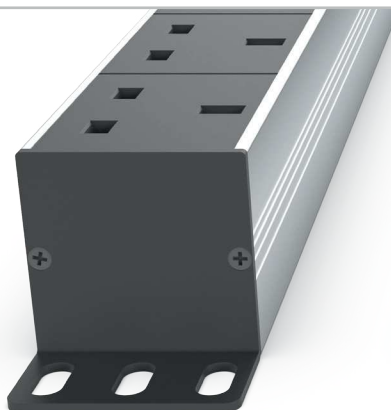

743.100.001



743.500.001



743.650.001

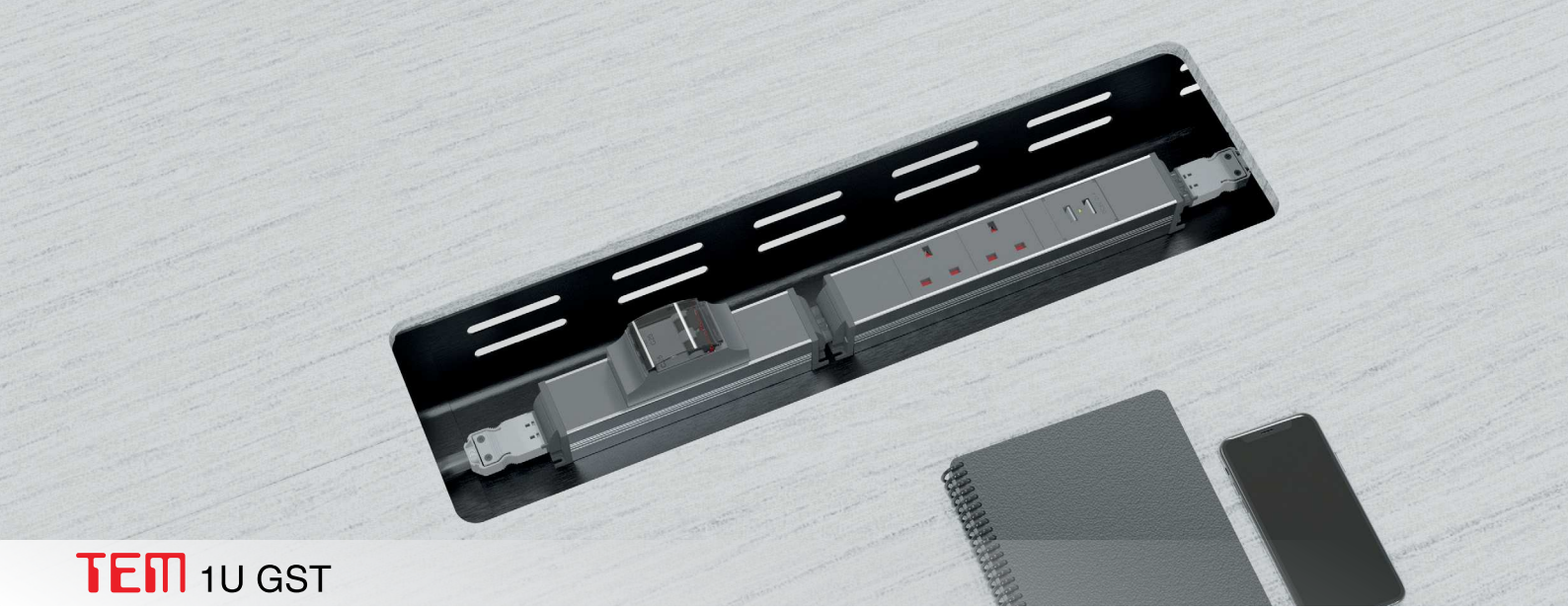

TEM 1U GST



4011.0000.003
Leakage Current



4014.0000.003
SPD + EMI Filter



4015.0000.003
SPD + Switch



4000.4020.0202.3
2 BS Sockets + Double USB Charger



4000.4040.003
4 BS Sockets



4003.4030.003
3 BS Sockets + Switch



725.3150.893
3m GST Female + Male



725.3150.913
3m GST Female + BS Plug



725.3150.933
3m GST Female + C14 Socket



TEM U62 PDU

Basic



Code

6200.0010.000
 6200.0012.000
 6200.0014.000
 6200.0016.000
 6200.0018.000
 6200.0020.000

Description

10 x 22.5 Profile + 2pcs 22.5 mm alu. top cover
 12 x 22.5 Profile + 2pcs 22.5 mm alu. top cover
 14 x 22.5 Profile + 2pcs 22.5 mm alu. top cover
 16 x 22.5 Profile + 2pcs 22.5 mm alu. top cover
 18 x 22.5 Profile + 2pcs 22.5 mm alu. top cover
 20 x 22.5 Profile + 2pcs 22.5 mm alu. top cover

U62 Product Examples



6200.4732.7811.0
 3 BS Sockets + 2 BS Red Sockets
 + Cat 6 + Cat 3



6200.4722.7822.0
 2 BS Sockets + 2 BS Red Sockets
 + 2 Cat 6 + 2 Cat 3



6200.4722.782111.0
 2 BS Sockets + 2 BS Red Sockets
 + Cat 6 + Cat 3 + Double USB Charger



6200.4723.7811.0
 2 BS Sockets + 3 BS Red Sockets
 + 2 Cat 6 + 1 Cat 3



6200.4733.7811.0
 3 BS Sockets + 3 BS Red Sockets
 + Cat 6 + Cat 3



6200.4030.153111.0
 3 BS Sockets + VGA + HDMI
 + USB Charger

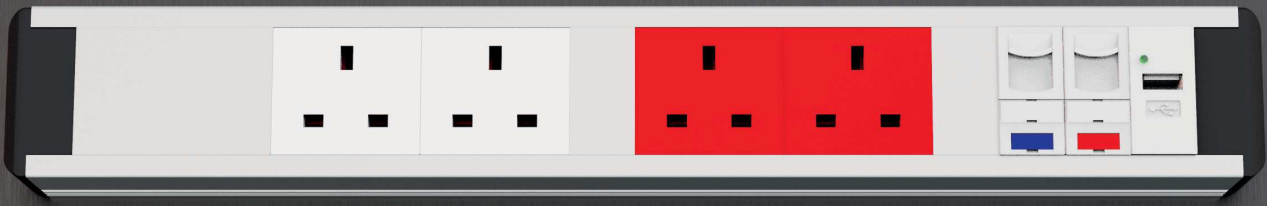

TEM U42 PDU

Basic



Code

- ④ 4200.4070.000
- 4200.4080.000
- 4200.4090.000
- 4200.1070.000
- ④ 4200.1080.000
- 4200.1090.000

Description

- ☹ 7 BS Sockets
- ☹ 8 BS Sockets
- ☹ 9 BS Sockets
- ☺ 7 BS Sockets
- ☺ 8 BS Sockets
- ☺ 9 BS Sockets

MCB



Code

- ④ 4201.4050.000
- 4201.4060.000
- 4201.4070.000
- 4201.1040.000
- ④ 4201.1060.000
- 4201.1080.000

Description

- ☹ 5 BS Sockets + MCB
- ☹ 6 BS Sockets + MCB
- ☹ 7 BS Sockets + MCB
- ☺ 4 Schuko Sockets + MCB
- ☺ 6 Schuko Sockets + MCB
- ☺ 8 Schuko Sockets + MCB

Switch



Code

- ④ 4203.4060.000
- 4203.4070.000
- 4203.4080.000
- 4203.1060.000
- ④ 4203.1070.000
- 4203.1080.000

Description

- ☹ 6 BS Sockets + Switch
- ☹ 7 BS Sockets + Switch
- ☹ 8 BS Sockets + Switch
- ☺ 6 Schuko Sockets + Switch
- ☺ 7 Schuko Sockets + Switch
- ☺ 8 Schuko Sockets + Switch

U42 Product Examples



4200.4723.7812.0
2 BS Sockets + 3 BS Red Sockets
+ 1 Cat 3 + 2 Cat 6



4200.4733.7811.0
3 BS Sockets + 3 BS Red Sockets
+ Cat 3 + Cat 6



4200.4732.7811.0
3 BS Sockets + 2 BS Red Sockets
+ Cat 3 + Cat 6



4200.4722.7822.0
2 BS Sockets + 2 BS Red Sockets
+ 2 Cat 3 + 2 Cat 6



4202.4050.000
5 BS Sockets + Leakage Current



4200.4040.110
4 BS Sockets + Double USB Charger

W42 Product Examples

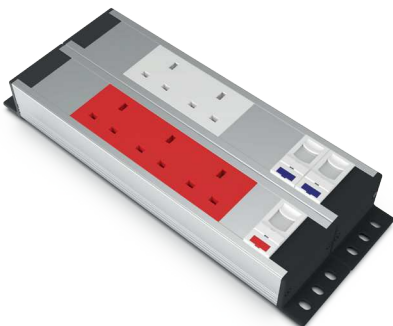

4300.4723.7812.0
2 BS Sockets + 3 BS Red Sockets
+ 2 Cat 6 + 1 Cat 3

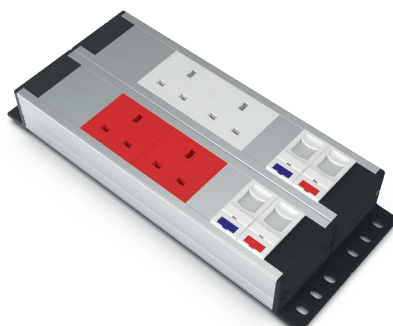

4300.4722.7822.0
2 BS Sockets + 2 BS Red Sockets
+ 2 Cat 6 + 2 Cat 3

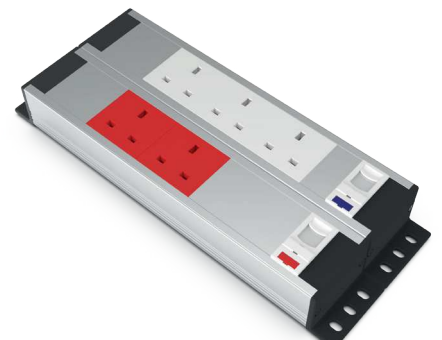

4300.4732.7811.0
3 BS Sockets + 2 BS Red Sockets
+ Cat 6 + Cat 3

H100 Mouting Kit



H100 Mounting Foot



1400.4744.7822.0

4 BS Sockets + 4 BS Red Sockets +
2 Cat 6 + 2 Cat 3
(H Double Column)

1400.4040.8142.0

4 BS Sockets + 2 Double
USB Chargers + 4 Cat 6
(H Double Column)

1400.4020.135222.0

2 BS Sockets + 2 USB Chargers
+ 2 VGA + 2 HDMI
(H Double Column)

1400.4040.120

2 BS Sockets +
2 Double USB Chargers
(H Double Column)

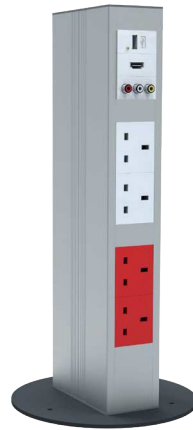
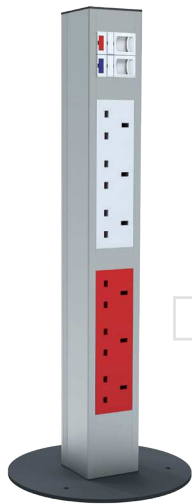

1100.4733.7811.0

3 BS Sockets + 3 BS Red Sockets
+ 1 Cat 6 + 1 Cat 3
(U62 Single Column)

1000.4744.136111.0

4 BS Sockets + 4 BS Red Sockets
+ 2 Double USB Charger
+ 2 HDMI + 2 RCA
(U62 Double Column)

1100.4722.840

2 BS Sockets + 2 BS Red Sockets
+ 4 Cat 6
(U62 Single Column)

1100.4040.3511.0

4 BS Sockets + 1 HDMI
+ 1 VGA
(U62 Single Column)

Column Profile Models



U62 Single



H100 Double



H62 Double



TEM Wireless Charge



USB

5V 2.1A 10,5 W

Wireless

5V 5 W - 7,5 W

Transmission Distance

≤ 8mm
(Önerilen: 2mm / 4mm)

Productivity

≥ 73%

Basic

Qi

Stylish and functional design

Indicates charging status with LED power indicator.

It keeps your phone safe with its non-slip surface.

It is compatible with cases up to 0-3 mm thick.

Feature to use USB port and Wireless charging at the same time.

Protection for over Temperature / Current

Supports wireless fast charging,
Up to 7.5W

Object Detection (FOOD) feature

Color

Black





Grey









TEM 044 PDU

	Code	Description	a (mm)	
	4400.4020.210	2 BS Sockets + Double USB Charger	244	1
	4400.7020.210	2 BS Red Sockets + Double USB Charger	244	1
	4400.4030.000	3 BS Sockets	223	1
	4400.7030.000	3 BS Red Sockets	223	1
	4404.4020.210	2 BS Sockets + Double USB Charger + SPD	319	1
	4404.7020.210	2 BS Red Sockets + Double USB Charger + SPD	319	1
	4404.4030.000	3 BS Sockets + SPD	298	1
	4404.7030.000	3 BS Red Sockets + SPD	298	1

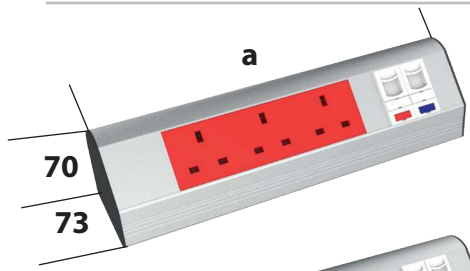

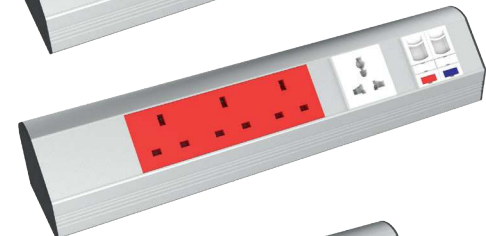
TEM G70 Desktop PDU

	Code	Description	a (mm)	
	7000.7030.7811.0	3 BS Red Sockets + Cat 6 + Cat 3	298,9	1
	7000.4722.7811.0	2 BS Sockets + 2 BS Red Sockets + Cat 6 + Cat 3	395,7	1
	7000.7631.7811.0	3 BS Red Sockets + Universal + Cat 6 + Cat 3	389,4	1
	7000.7030.178111.0	3 BS Red Sockets + Cat 6 + Cat 3 +1 USB Charger	321,4	1

* a = Total product size including side covers

Mounting Aparat



Code	Description	a (mm)
740.050.030	Small Size Mounting Feet	$30 \geq a \geq 18$
740.050.070	Big Size Mounting Feet	$70 \geq a \geq 58$

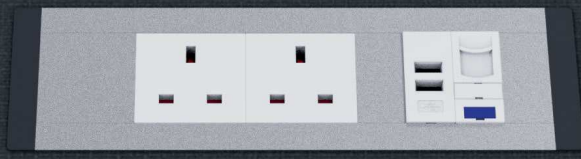

* a = Table thickness
 Minimum table thickness for 30mm mounting feet = 18mm
 Minimum table thickness for 70mm mounting feet = 58mm

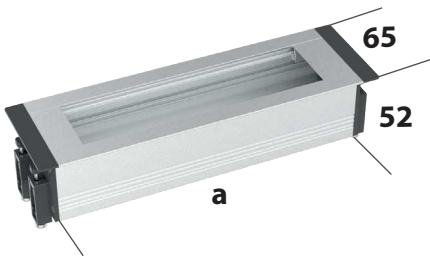

TEM Power Frame

Empty Power Frame	Code	Description	Cut Size a+6(mm)	a (mm)	
	7200.0010.000	10 x 22,5 Profile + 22.5mm Alu. top cover	231 x 55	225	1
	7200.0012.000	12 x 22,5 Profile + 22.5mm Alu. top cover	276 x 55	270	1
	7200.0014.000	14 x 22,5 Profile + 22.5mm Alu. top cover	321 x 55	315	1
	7200.0016.000	16 x 22,5 Profile + 22.5mm Alu. top cover	366 x 55	360	1

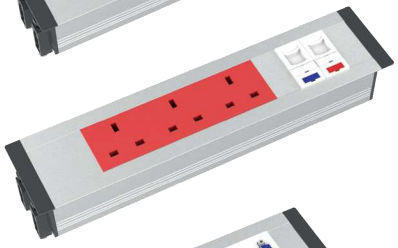
* **a** = Aluminum length without side covers
a+26 = Total product length with side covers

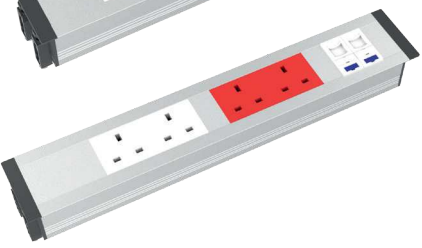
	Code	Description	Cut Size a+6(mm)	a (mm)
	7200.4020.110	2 BS Sockets + 1 USB Charger	221,1 x 55	215,1
	7200.7030.7811.0	3 BS Red Sockets + Cat 6 + Cat 3	294,9 x 55	288,9
	7200.4020.1511.0	2 BS Sockets +1 USB Charger + VGA	243,6 x 55	237,6
	7200.4722.0802.0	2 BS Sockets + 2 BS Red Sockets + 2 Cat 6	391,7 x 55	385,7



TEM Cable Grommet

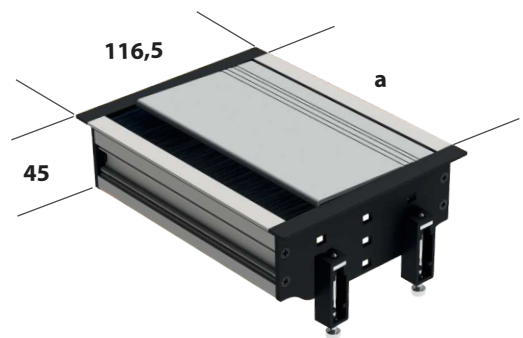
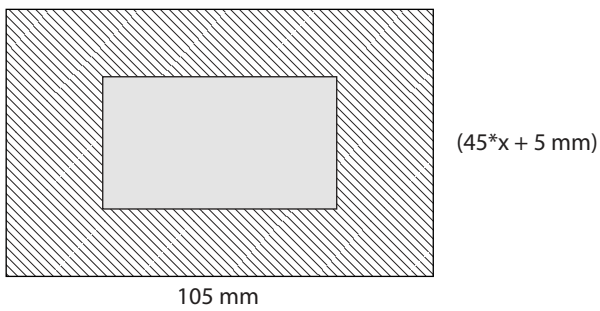

Empty Cable Grommet	Code	Description	Cut Size		
			a+5 (mm)	a (mm)	
	7100.0010.000	10 x 22,5mm Profile + 2pcs 22,5mm alu. top cover	230 x 105	225	1
	7100.0012.000	12 x 22,5mm Profile + 2pcs 22,5mm alu. top cover	275 x 105	270	1
	7100.0014.000	14 x 22,5mm Profile + 2pcs 22,5mm alu. top cover	320 x 105	315	1
	7100.0016.000	16 x 22,5mm Profile + 2pcs 22,5mm alu. top cover	365 x 105	360	1

* **a** = Aluminum length without side covers
a+25 = Total product length with side covers



TEM Flip Power Frame

Empty Flip Power Frame

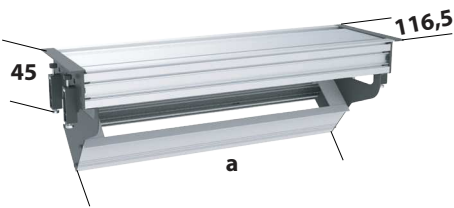

Code

Description

Cut Size a+35(mm)

a (mm)



7300.0010.0	10 x 22.5mm Profile + 2pcs 22.5mm alu. top cover	260x105	225	1
7300.0012.0	12 x 22,5mm Profile + 2pcs 22.5mm alu. top cover	305x105	270	1
7300.0014.0	14 x 22,5mm Profile + 2pcs 22.5mm alu. top cover	350x105	315	1
7300.0016.0	16 x 22,5mm Profile + 2pcs 22.5mm alu. top cover	395x105	360	1

* **a** = Aluminum length without side covers

a+56 = Total product length with side covers

Basic

Code

Description

Cut Size a+35(mm)

a (mm)



7300.4020.7811.0	2 BS Sockets + Cat 6 + Cat 3	272,6x 105	237,6
7300.4020.110	2 BS Sockets + 1 USB Charger	150,1 x 105	215,1
7300.4722.7811.0	2 BS Sockets + 2 BS Red Sockets + Cat 6 + Cat 3	420,7 x 105	385,7
7300.4631.210	3 BS Sockets + Universal Sockets + Double USB Charger	414,4 x 105	379,4

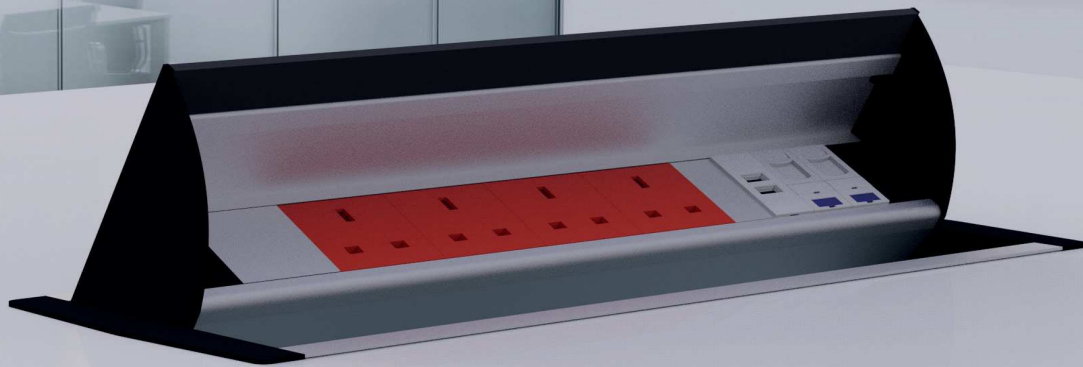

TEM Horizontal Desk Socket

Empty H. Desk Sockets

Code

Description

Cut Size a+70(mm)

a (mm)



7400.0010.000	10 x 22.5 Profile + 2pcs 22,5mm alm. top cover	295 x 135	225	1
7400.0012.000	12 x 22.5 Profile + 2pcs 22,5mm alm. top cover	340 x 135	270	1
7400.0014.000	14 x 22.5 Profile + 2pcs 22,5mm alm. top cover	385 x 135	315	1
7400.0016.000	16 x 22.5 Profile + 2pcs 22,5mm alm. top cover	430 x 135	360	1

* **a** = Usable space in Horizontal Desk housing

a+70 = Table cut length

a+100 = Total product length including side covers

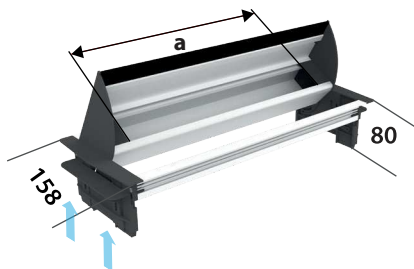

Code

Description

Cut Size a+70(mm)

a (mm)

7400.4040.820	4 BS Sockets + 2 Cat 6	387,7x135	317,7
---------------	------------------------	-----------	-------







7400.4722.7811.0	2 BS Sockets + 2 BS Red Sockets + Cat 6 + Cat 3	433,2x135	363,2
------------------	--	-----------	-------

7400.4724.842	2 BS Sockets + 4 BS Red Sockets + 4 Cat 6 + Socket input	580,8x135	510,8
---------------	---	-----------	-------

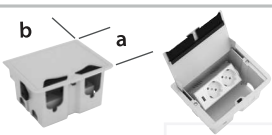
7400.4733.840	3 BS Sockets + 3 BS Red Sockets + 4 Cat 6	580,8x135	510,8
---------------	--	-----------	-------



TEM Table Groups with Plastic Body

	Code	Description	Module	a	b	h
	800.025.02X	Socket Box(Brushed-Grey, Black, White)	2.5x45	126	175	104
	800.025.022	Socket Box (Metallic Coating)				
	800.025.12X	Sockets Box(Brushed-Grey, Black, White)	2.5x45	80	170	103
	800.025.122	Socket Box(Metallic Coating)				
	800.045.02X	Socket Box(Brushed-Grey, Black)	4.5x45	127	253	63
	800.045.022	Socket Box(Brushed - Metallic Coating)				
	800.045.12X	Socket Box(Brushed-Grey, Black)	4.5x45	127	253	120
	800.045.122	Sockets Box(Brushed - Metallic Coating)				
	800.050.02X	Socket Box(Brushed-Grey, Black, White)	5x45	126	175	104
	800.050.022	Socket Box(Metallic Coating)				
	800.090.02X	Socket Box(Brushed-Grey, Black)	9x45	127	253	120
	800.090.022	Socket Box(Brushed - Metallic Coating)				
<p>X = 1 Grey X = 3 Black X = 6 White</p>						

TEM Table Groups with Aluminium Body

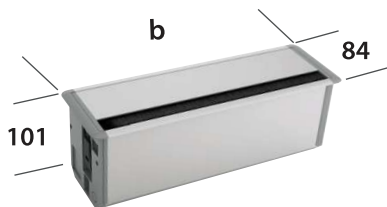

Code	Module	b
810.020.01X	2x45	132
810.030.01X	3x45	171
810.040.01X	4x45	238
810.050.01X	5x45	279
810.060.01X	6x45	342
810.070.01X	7x45	387
810.080.01X	8x45	449
810.090.01X	9x45	474
810.0100.01X	10x45	534
<p>X = 1 Anodized X = 3 Black X = 6 White</p>		

Floor Box Housing

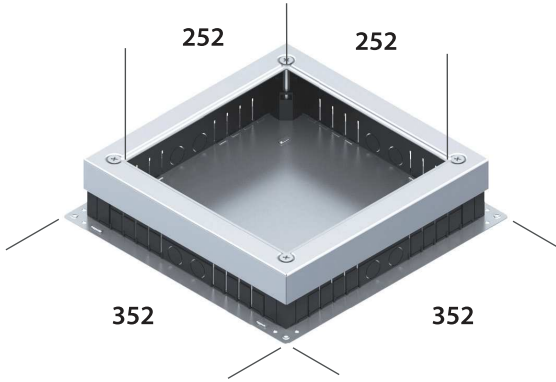

205.352.000

Underfloor Sockets Box (Empty Box)
Capacity 18 pcs, 22,5 module



206.252.000

Code	Dimensions(mm)	Weight(Kg)
205.352.000	352x352	2.563
206.252.000	252x252	1.461

113X210mm
Surface Sockets Boxes



210.0000.0000
113x210x70mm



210.4700.4400
4 BS Sockets + 4 BS Red Sockets



212.4000.6000
6 BS Sockets + 2(1x25A) MCB

210X280mm
Surface Sockets Boxes



280.0000.0000
210x280x70mm



280.4700.6600
6 BS Sockets + 6 BS Red Sockets



282.4700.6300
6 BS Sockets + 3 BS Red Sockets
+ 2 (1x25A) Sigorta

TEM Modular
45mm Sockets

16A 2P+E 200-250 V~



250.216.150
Screw Assembly schuko
Socket 45°



250.316.150
Screw Assembly unischuko
Socket 45°



245.216.150
Schuko Socket Single Terminal



245.316.150
Unischuko Socket Single Terminal



246.216.150
Schuko Socket Single
Terminal 45°



246.316.150
Unischuko Socket Single
Terminal 45°



345.216.150
Schuko Socket Double Terminal



345.316.150
Unischuko Socket Double Terminal



346.216.150
Schuko Socket Double
Terminal 45°



346.316.150
Unischuko Socket Double
Terminal 45°



247.216.150
French Socket Double
Terminal 45°



347.216.150
French Socket Double
Terminal

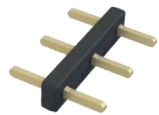

740.061.002
Socket
Connector



350.216.150
Shuko Socket Double
Terminal 45°



350.316.150
Unischuko Socket Double
Terminal 45°



350.216.160
Schuko Mosaic Socket
with cover



350.316.160
Unischuko Mosaic Socket
with cover

TEM International
Plug & Socket



721.170.150
45x45mm Universal Socket



721.160.150
45x45mm USA Socket



721.130.150
45x45mm British Socket



721.130.151
51x45mm British Socket



721.130.300
British Plug



Schuko Type

16A 2P+E 200-250 V~



	Description	Product Code	Child Protection Product Code
Cable	2 way Schuko socket strip	310.002.003	310.002.103
	3 way Schuko socket strip	310.003.003	310.003.103
	4 way Schuko socket strip	310.004.003	310.004.103
Terminal	2 way Schuko socket strip	311.002.003	311.002.103
	3 way Schuko socket strip	311.003.003	311.003.103
	4 way Schuko socket strip	311.004.003	311.004.103
Double Terminals	2 way Schuko socket strip	312.002.003	312.002.103
	3 way Schuko socket strip	312.003.003	312.003.103
	4 way Schuko socket strip	312.004.003	312.004.103

Unischuko Type

16A 2P+E 200-250 V~

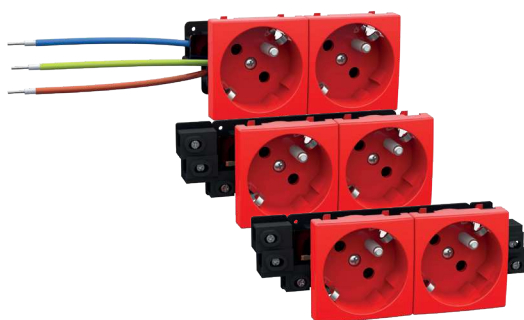

	Description	Product Code	Child Protection Product Code
Cable	2 way Unischuko socket strip	320.002.002	320.002.102
	3 way Unischuko socket strip	320.003.002	320.003.102
	4 way Unischuko socket strip	320.004.002	320.004.102
Terminal	2 way Unischuko socket strip	321.002.002	321.002.102
	3 way Unischuko socket strip	321.003.002	321.003.102
	4 way Unischuko socket strip	321.004.002	321.004.102
Double Terminals	2 way Unischuko socket strip	322.002.002	322.002.102
	3 way Unischuko socket strip	322.003.002	322.003.102
	4 way Unischuko socket strip	322.004.002	322.004.102

French Type

16A 2P+E 200-250 V~

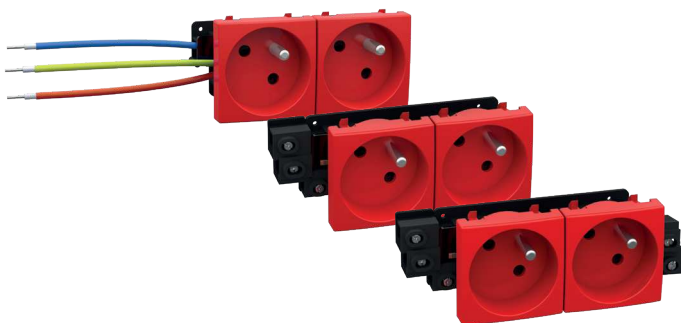

	Description	Product Code
Cable	2 way French socket strip	350.002.102
	3 way French socket strip	350.003.102
	4 way French socket strip	350.004.102
Terminal	2 way French socket strip	351.002.102
	3 way French socket strip	351.003.102
	4 way French socket strip	351.004.102
Double Terminal	2 way French socket strip	352.002.102
	3 way French socket strip	352.003.102
	4 way French socket strip	352.004.102

Computer Type

10A 2P+E 200-250 V~

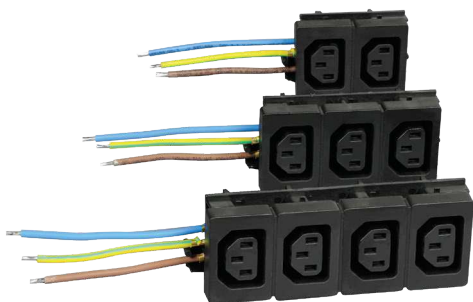

Description	Product Code
2 way Computer socket strip	330.002.004
3 way Computer socket strip	330.003.004
4 way Computer socket strip	330.004.004

British Type

13A 2P+E 200-250 V~



	Description	Product Code
Double Terminals	2 way British socket strip	340.002.003
	3 way British socket strip	340.003.003
	4 way British socket strip	340.004.003
Cable	2 way British socket strip	342.002.003
	3 way British socket strip	342.003.003
	4 way British socket strip	342.004.003

45x45mm Tv Sockets



723.000.150
TV Socket



723.000.300
TV Male Socket $\varnothing 9.52\text{mm}$



723.000.400
SAT Wall Socket F Connector

VGA Connectors



715.300.001
22,5 x 45mm 6 + 2 Screw-in
VGA Faceplate



715.300.002
14 + 2 Push-in



715.300.003
45x45mm VGA Connector F
Connectors Faceplate



715.300.004
22.5 x 45mm VGA
Connector Faceplate

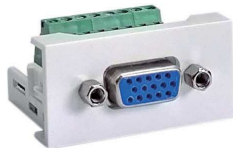

715.300.005
15 Terminal Input



715.300.007
Vga Connector 9 Pin



715.300.009
45x5mm VGA Connector
B Socket Faceplate

RCA & STEREO Connectors



715.500.002
22.5x45mm RCA Connector
Screw-in Faceplate



715.500.001
22.5x45mm RCA Connector
Faceplate



715.600.001
22.5x45mm Stereo Connector
Faceplate

HDMI Connectors



715.400.001
22.5 x 45mm HDMI Connector
Female-Female 90°
Faceplate



715.400.002
22.5x45mm HDMI Connector
Female-Female 180°
Faceplate



715.400.003
22.5x45mm HDMI Connector
Type A Female-Female
Faceplate



715.400.004
HDMI Connector Type A
Female-Female
Keystone



715.400.005
HDMI Connector Type
A Female-Female Keystone
with Cable

HDMI Connector



715.400.008
45x45mm HDMI Connector
Type A Female-Female Faceplate

DISPLAY Connector



715.700.001
45x45mm Display Port
Connector Faceplate

XLR Connector



715.600.002
45x45mm XLR Female
Socket Faceplate

USB Connectors



715.200.004
22.5x45mm USB Connector
Standard A USB AF/AF
90° Faceplate



715.200.005
22.5x45mm USB Connector
Standard A USB AF/AF
180° Faceplate



715.200.006
22.5x45mm USB Connector
Standard A Faceplate



715.200.001
22.5x45mm USB Connector Standard A
Faceplate



715.200.002
Standard A USB Connector Female-Female
Keystone



715.200.003
Standard A USB Connector
Female-Female Keystone with cable

TEM USB Chargers



715.200.110 - White
715.200.111 - Black
22,5x45mm USB Charger Type A - 2A



715.200.100 - White
715.200.101 - Black
22,5x45mm USB Charger Type A - 1A



715.200.200 - White
715.200.201 - Black
22,5x45mm USB Charger Type A-2.1A



715.100.100 - White
715.100.101 - Black
45x45mm USB Charger
Type A/C 2.1A



715.100.110 - White
715.100.111 - Black
45x45mm USB Charger
Type A/A 2.1A

tem SPD

TiP 3 Surge Protection

U_c : 255V - 50-60 Hz

U_{oc} : 5/10 kV

I_n : 2,5/5 kA

U_p : $\leq 1,5$ kV



734.612.0120.1



734.612.0120.0

On - Off Switch

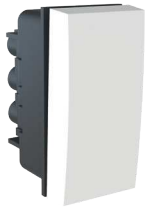

722.225.021

22,5x45mm without illuminated Switch



722.225.112

22,5x45mm with illuminated Switch



722.045.022

45x45mm without illuminated Double Switch



722.045.122

45x45mm with illuminated Double Switch



722.225.010
22,5x45mm 10A
without illuminated
Switch

722.225.110
22,5x45mm 10A
with illuminated
Switch



722.045.012
45x45mm 16A
without illuminated
Switch

722.045.112
45x45mm 16A
with illuminated
Switch



722.045.011
45x45mm
2x10A
without illuminated
Double Switch

722.045.111
45x45mm
2x10A
with illuminated
Double Switch



723.225.016
Overload Protector
22x45mm

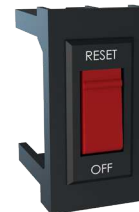

723.225.116
Switch of overload
protection
22x45mm



Faceplate - Connectors

Cable Trunking Phone
Data Covers

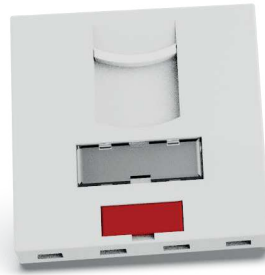

710.100.103
45x45mm Faceplate
with Shutter



710.100.104
22,5x45mm Faceplate
with Shutter

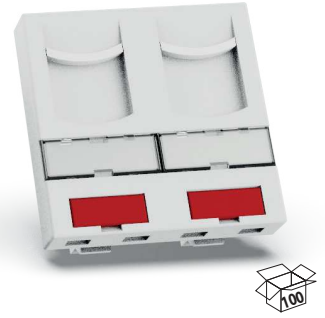

710.100.105
45x45mm Double Faceplate
with Shutter

Under Floor / Cable Trunking -Data Covers

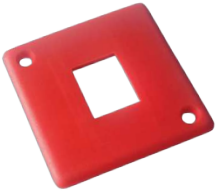

708.100.010
Faceplate for under
floor - 50x50mm



708.100.020
Faceplate for under
floor - 50x50mm



709.100.103
Plastic cover for keystone
45x45mm



709.100.104
Plastic cover for keystone
22,5x45mm

Gap Covers / Cable Trunking- Data Covers



709.200.103
Plastic Cover
45x45mm



709.200.104
Plastic Cover
22,5x45mm



710.100.111
Flat Faceplate
22,5x45mm



710.100.106
Flat Faceplate
45x45mm



710.100.107
Flat Faceplate
45x45mm

45x45mm Cable Trunking Covers/ Telephone- Data Plug



710.100.108
Lift up faceplate
45x45mm



710.100.109
Lift up faceplate
45x45mm



710.100.110
Lift up faceplate
45x45mm



710.100.350
CAT5 DATA Plug



710.100.360
CAT6 DATA Plug



710.100.332 - 2 PIN
710.100.334 - 4 PIN
710.100.336 - 6PIN
Telephone Plug

Phone -Data Connectors / Female - Female Phone - Data Connectors



715.100.050
CAT5E DATA



715.100.060
CAT6 DATA



715.100.061
CAT6A DATA



715.100.030
CAT3 TELEPHONE



715.200.050
CAT5E DATA



715.200.060
CAT6 DATA



715.200.061
CAT6A DATA



715.200.030
CAT3 TELEPHONE

724.021.000
Movable Gst Socket
Female



724.011.000
Movable Gst Socket
Male



724.000.010
Plastic Lock



Computer Sockets



720.130.150
IEC C13 10A
Push - in



720.130.160
IEC C13 10A
Screwed



720.140.320
IEC C14 10A
Push-in



720.140.340
IEC C14 10A
Screwed



720.190.150
IEC C19 16A
Push-in



720.190.160
IEC C19 16A
Screwed



720.200.320
IEC C20 16A
Push-in



720.240.340
IEC C20 16A
Screwed



720.130.200
IEC C13 10A
Inline Socket



720.190.200
IEC C19 16A
Inline Socket



720.140.300
IEC C14 10A
Inline Plug



720.200.300
IEC C20 16A
Inline Plug

45x45mm Computer Sockets / 2.5mm² Socket Terminals



720.140.321
IEC C14 10A
45x45mm



720.200.321
IEC C20 16A
45x45mm



724.020.000
GST Socket Female



724.010.000
GST Socket Male



720.400.200 - White
720.400.201 - Black
720.400.202 - Red
Male - Female Set Sockets



720.500.002 2 way
720.500.003 3 way
720.500.004 4 way
720.500.005 5 way
Terminals

TEM®

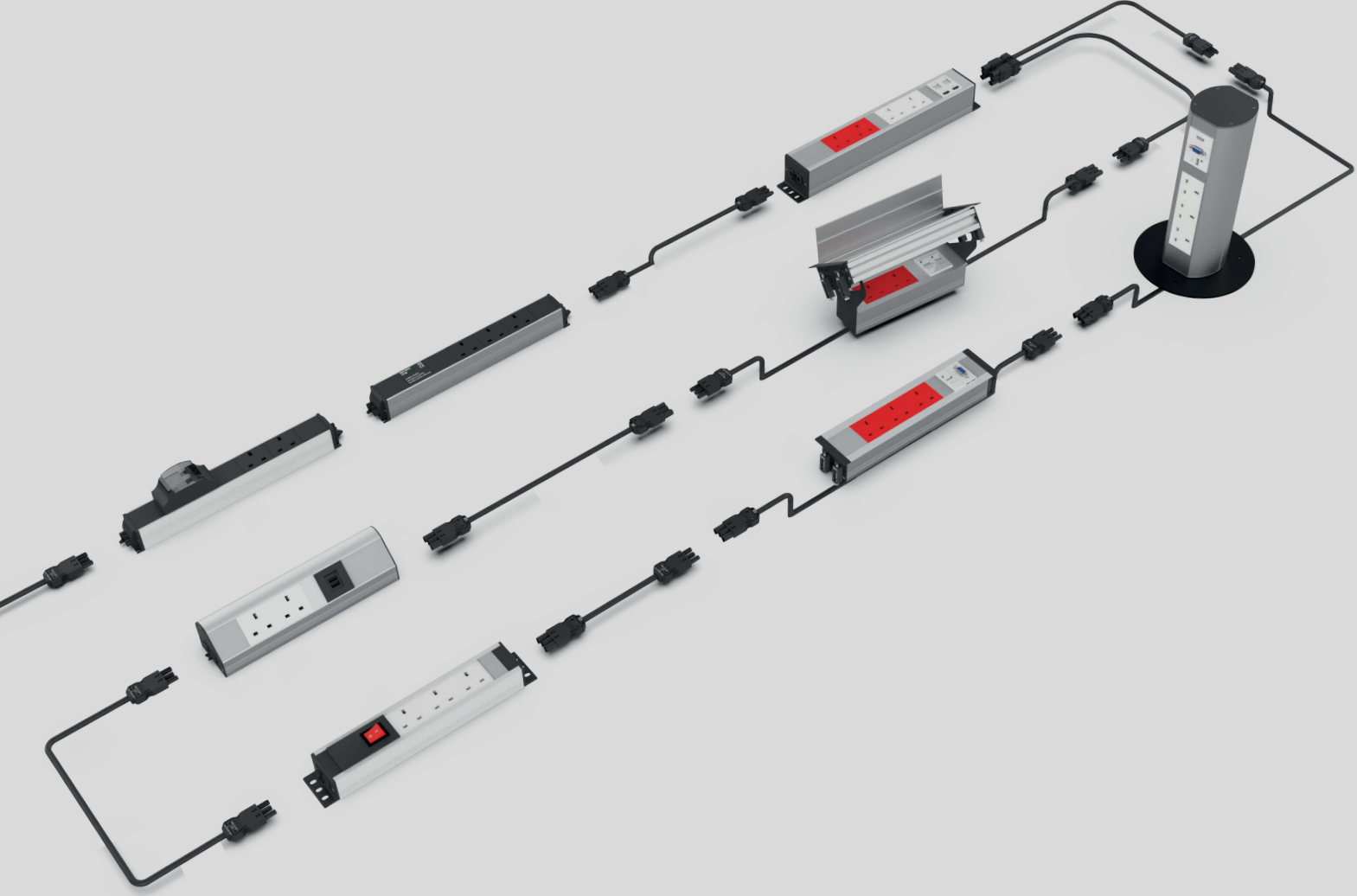



**TEM TEKNİK ELEKTRİK MALZEMELERİ
SANAYİ VE TİCARET ANONİM ŞİRKETİ**

 Selimpaşa Ortaköy Sanayi Bölgesi, İltter Bulvarı,
Mor Menekşe Sok, No:5 34590
Silivri / İSTANBUL / TURKEY

 +90 212 485 19 00

 +90 212 485 15 33

 www.temteknik.com

 info@temteknik.com

