



TEM®

TEM TEKNİK ELEKTRİK MALZEMELERİ SANAYİ VE TİCARET ANONİM ŞİRKETİ

Factory

No:5, Selimpaşa Ortaköy Sanayi District,
İlter Avenue, Mor Menekşe St.
Silivri / İSTANBUL / TURKEY

T. +90 212 485 19 00 Pbx

F. +90 212 485 15 33

Fabrika

Selimpaşa Ortaköy Sanayi Bölgesi,
İlter Bulvarı, Mor Menekşe Sok. No:5
Silivri / İSTANBUL / TÜRKİYE

T. +90 212 485 19 00 Pbx

F. +90 212 485 15 33

TEM[®]



2020
CATALOG

İçindekiler / Contents



Fiş & Prizler/Plugs & Sockets

- 2-3** Monofaze Prizler
Single phase Sockets
- 4** Monofaze Kauçuk Fiş & Prizler
Single phase Rubber Plugs & Sockets
- 5-6** Trifaze Kauçuk Fiş & Prizler
Three phase Rubber Plugs & Sockets
- 7-24** CEE Norm Fiş & Prizler
CEE Norm Plugs & Sockets



Güç Kutuları/Power Boxes

- 26-36** Kombinasyon Kutuları
Combination Boxes
- 37-39** Termoplastik Buatlar
Thermoplastic Enclosures
- 40-42** Dahili Priz Kutuları
Surface Socket Boxes
- 43-60** Dağıtım Panoları
Distribution Boards
- 61-69** Kablo Makaraları
Cable Reels



Alüminyum Kanalları PDU Powers

- 71-82** Masa Grubu Prizler
Desk Type Sockets
- 83-86** G Tipi Priz
G Type Socket
- 87-90** Dikey Masa Prizi
Vertical Desk Socket
- 91-117** U Tipi Prizler
U Type Sockets
- 118-119** Aydınlatma Çözümleri
Lighting Solution

120-128 Kanal Üstü Prizler / Sockets for Cable Trunkings

129-134 Kanal Üstü Aksesuarlar / Accessories for Cable Trunkings

TEM®

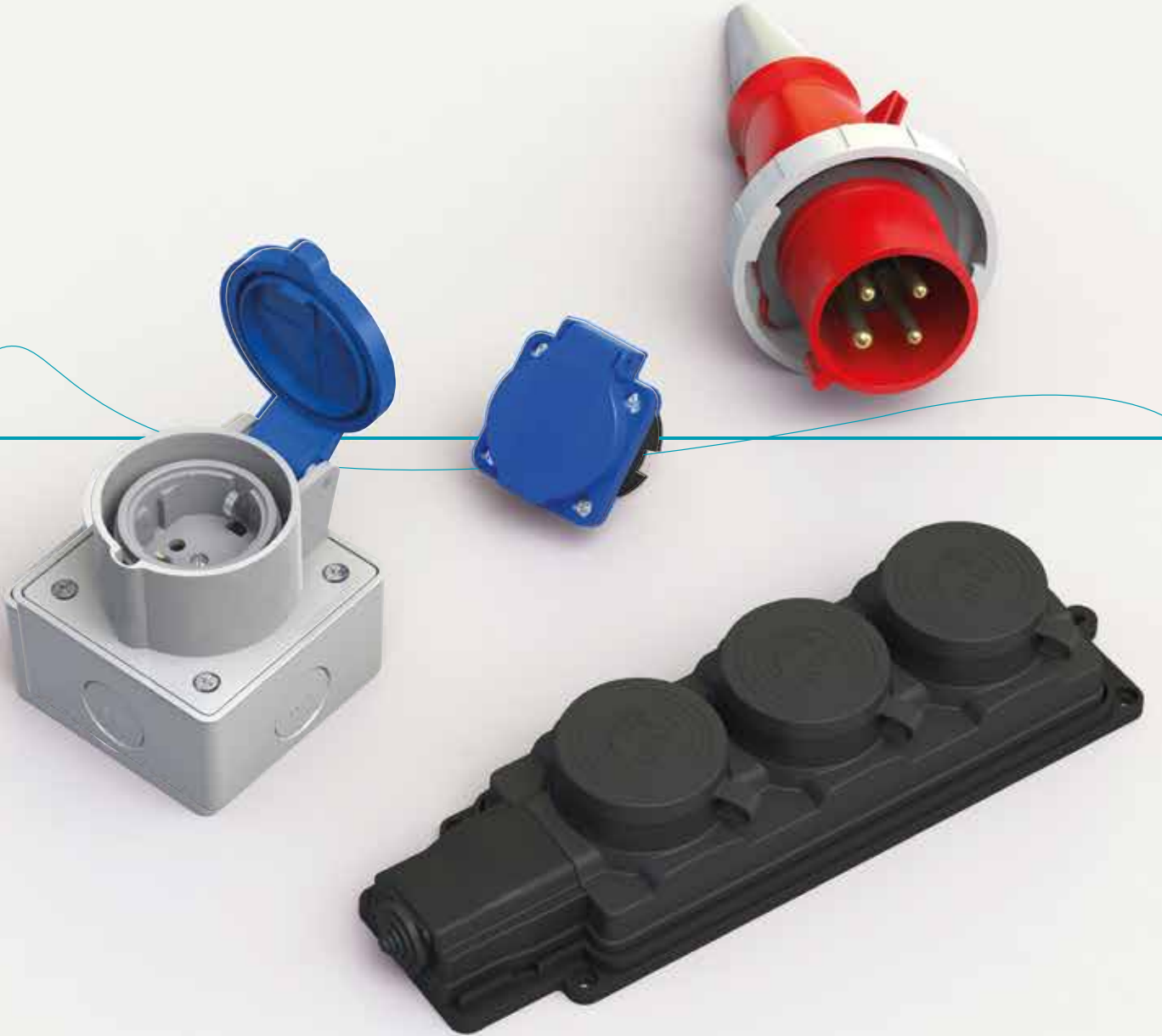

FİŞ & PRİZLER

Plugs & Sockets

Monofaze Prizler / Single Phase Sockets

Çift Girişli IP54

Şebeke Tipi Pano Prizi
/ Schuko type panel socket
216.216.160



16A
200-250V

2P

IP 54

50,5 gr.

48

UPS Tipi Pano Prizi
/ Unischuko type panel socket
216.316.160



16A
200-250V

2P

IP 54

54,5 gr.

48

Fransız Tipi Pano Prizi
/ French type panel socket
217.216.160



16A
200-250V

2P

IP 54

53 gr.

48

Tek Girişli IP44

Şebeke Tipi Pano Prizi
/ Schuko type panel socket
216.216.150



16A
200-250V

2P

IP 44

42,5 gr.

48

UPS Tipi Pano Prizi
/ Unischuko type panel socket
216.316.150



16A
200-250V

2P

IP 44

46 gr.

48

Vidalı Prizler 45°
/ Screwed Sockets 45°
250.216.150 250.316.150

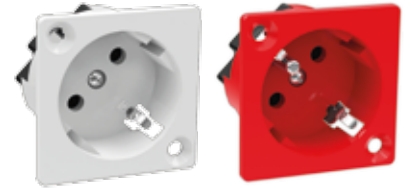

16A
200-250V

2P

35 gr.

60

Eğik Makine Prizi
/ Panel mounting socket
670.116.160



16A
200-250V

2P

IP 67

106 gr.

12

Kilitli Kapaklı Eğik Makine Prizi
/ Panel mounting socket
440.116.160



16A
200-250V

2P

IP 44

106 gr.

12

Makine Prizi
/ Panel mounting socket
440.116.150



16A
200-250V

2P

IP 44

106 gr.

12

Dik Kasalı Duvar Prizi
/ Wall mounting socket with straight box
440.116.151



16A
200-250V

2P

IP 44

106 gr.

12

Eğik Kasalı Duvar Prizi
/ Wall mounting socket with angled box
440.116.152



16A
200-250V

2P

IP 44

106 gr.

12

Eğik Kasalı Duvar Prizi + Pano Prizi
/ Wall mounting socket with angled box+Schuko
440.116.153



16A
200-250V

2P

IP 44

106 gr.

12



Ray Tipi Prizler Din Rail Sockets



Ray Tipi Şebeke Prizi
/ Din rail schuko socket



217.216.170	Ledsiz / without LED
217.216.171	Ledli / with LED



Ray Tipi UPS Prizi
/ Din rail UPS socket



217.316.170	Ledsiz / without LED
217.316.171	Ledli / with LED



Ray Tipi Fransız Prizi
/ Din rail french socket



217.416.170	Ledsiz / without LED
217.416.171	Ledli / with LED



Kauçuk Fiş & Prizler / Rubber Plugs & Sockets

EKO Kauçuk Fiş / ECO rubber plug

- Ref Code: 215.116.300
- Ref Code: 215.316.300



Kauçuk Eğik Fiş / rubber plug

- Ref Code: 215.116.320
- Ref Code: 215.316.320



- Şebeke Priz / Schuko socket
- Fransız Priz / French socket

Düz Uzun Kauçuk Fiş / Single phase schuko rubber plug Ref Code: 215.116.301



Kauçuk Seyyar Priz / rubber connector • Ref Code: 215.116.200 • Ref Code: 215.316.200



Kauçuk Tekli Duvar Prizi / Rubber wall mounting socket • Ref Code: 215.116.101 • Ref Code: 215.316.101



Kauçuk İkili Duvar Grup Prizi / Rubber two way wall multi socket • Ref Code: 215.116.102 • Ref Code: 215.316.102



Kauçuk Üçlü Duvar Grup Prizi / Rubber three way wall multi socket • Ref Code: 215.116.103 • Ref Code: 215.316.103



Kauçuk Dörtlü Duvar Grup Prizi / Rubber four way wall multi socket • Ref Code: 215.116.104 • Ref Code: 215.316.104

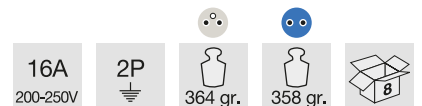

Trifaze Kauçuk Fiş & Prizler / Three Phase Rubber Plugs & Sockets

Trifaze Kauçuk Fiş
/ Three phase plug
540.425.300



Trifaze Kauçuk Seyyar Prizi
/ Three phase rubber connector
540.425.200



Trifaze Kauçuk Duvar Prizi
/ Three phase rubber Socket
540.425.110



1Monofaze + 1Trifaze Kauçuk Duvar Prizi
/ 1Single Phase + 1Three phase rubber Socket
540.425.111



2Monofaze + 1Trifaze Kauçuk Duvar Prizi
/ 2Single Phase + 1Three phase rubber Socket
540.425.112



1Monofaze + 2Trifaze Kauçuk Duvar Prizi
/ 1Single Phase + 2Three phase rubber Socket
540.425.121



Üçlü Trifaze Kauçuk Grup Prizi
/ Three way three phase rubber Socket
540.425.130



Pano Prizi
/ Panel mounting socket
540.425.150



Dik Kasalı Duvar Prizi
/ Wall mounting socket with straight box
540.425.151



Eğik Kasalı Duvar Prizi
/ Wall mounting socket with angled box
540.425.152



Eğik Kasalı Duvar Prizi + Schuko
/ Wall mounting socket with angled box+Schuko
540.425.153



Trifaze Fiş & Prizler / Three Phase Plugs & Sockets

Kaucuk Trifaze 16A Eğik Fiş
/ Three phase rubber 16A angled plug
544.316.300



Pano Prizi
/ Panel mounting socket
544.316.150



Dik Kasalı Duvar Prizi
/ Wall mounting socket with straight box
544.316.151



Eğik Kasalı Duvar Prizi
/ Wall mounting socket with angled box
544.316.152



Eğik Kasalı Duvar Prizi + Schuko
/ Wall mounting socket with angled box+Schuko
544.316.153



Trifaze Kaucuk 32A fiş
/ Three phase rubber 32A plug
544.332.300



Pano Prizi
/ Panel mounting socket
544.332.150



Dik Kasalı Duvar Prizi
/ Wall mounting socket with straight box
544.332.151



Eğik Kasalı Duvar Prizi
/ Wall mounting socket with angled box
544.332.152



Eğik Kasalı Duvar Prizi + Schuko
/ Wall mounting socket with angled box+Schuko
544.332.153



Pin Topraklama Saati / Clock Face Earth Position

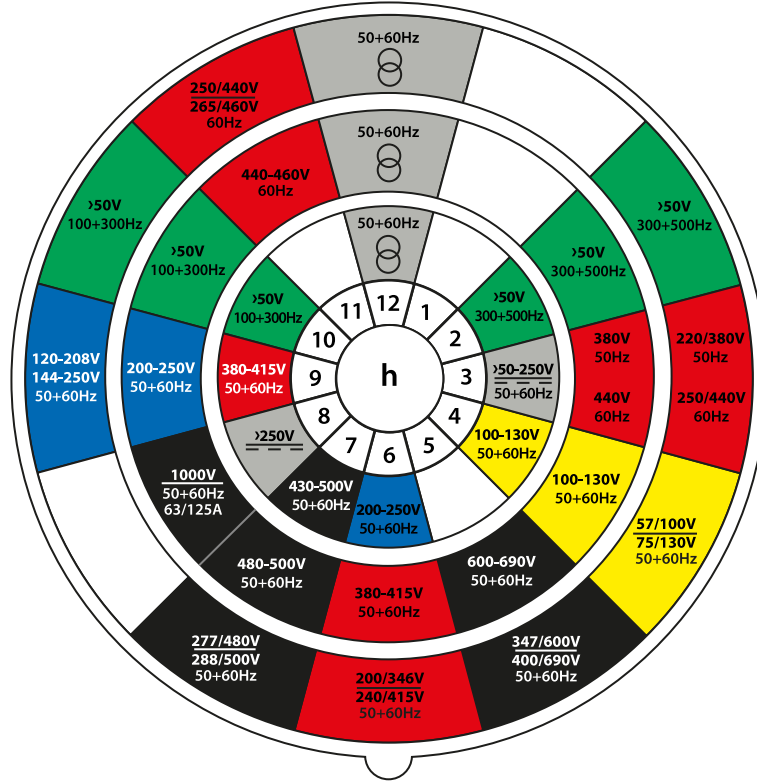

In order to recognize earth pin, you just have to look frontally at the socket and put the major keyway at 6 o'clock. In this way it is easy to identify the earth pin, Wich is always bigger that the others.

Örnekler / Some examples:

- h3, Soğutmalı konteynerlerde / Refrigerated container
- h4, Özel voltajlar / Especific voltages
- h6, Stantard kullanımı / Stantard use
- h7, Özel voltajlar / Especific voltages
- h11, Gemi tasisatında / Marine instalation

- Yürürlükte olan ulusal ve uluslararası standrtlara yugun olarak üretilen **TEM** CEE Norm Fiş & Prizler, kaliteli bileşenleri ile güvenliği garanti eder.

All **TEM** CEE Norm Plug & Sockets are manufactured in compliance with the national and international regulations in force with good quality component parts guarantee the safety.

- IP 44 ve IP 67 gibi yüksek koruma dereceleri, değişik nominal akım değerleri (16A, 32A, 63A) ve uygulama alanına göre çeşitli şekilleri (duvar tipi, pano tipi, eğik, düz, kasalı...) mevcuttur.

Different execution styles (wall mounting, panel mounting, angled, straight, with box) are available like high protection degrees (IP 44 AND IP 67) and different nominal currents (16A, 32A, 63A).

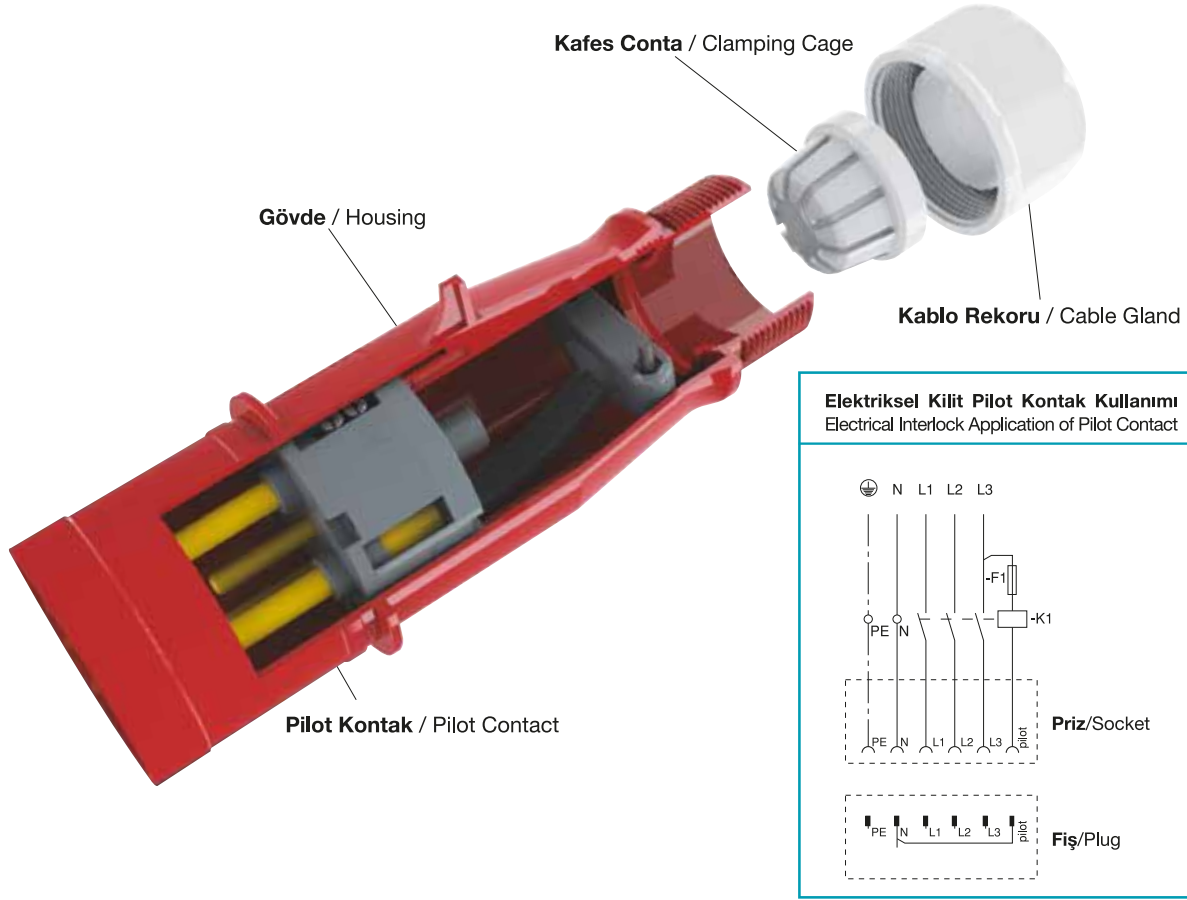

Standards	Nominal Voltage Un (V)	Poles	Color	Nominal Current In (A)	h	IP	Hz.	Installation Temperature	
EN 60309-1-2 TS 7205-7206	110	3	Yellow	16	4	44	50-60	-25°C	+60°C
	220	3	Blue	16	6	44			
	380	4	Red			44-67			
	380	5	Red	44-67					
	220	3	Blue	32		44-67			
	380	4	Red	44-67					
	380	5	Red	63		44-67			
	380	4	Red	44-67					

Nominal Current in (A)	Terminal	Terminal Cable Capacity mm ² NYA	
		min.	max.
A	mm ²		
16	20	1,5	4
32	50	2,5	10
63	113	6	25

Material	Installation Temperature	Heat Resistance Level
PA	-25°C +60°C	V2

CEE NORM Fiş & Prizler / CEE Plugs & Sockets

16A

4h

3Poles

2P+E

IP44

110-130 V~

* Teknik resimler için bakınız:
Sayfa 136-137

* Check technical drawings on:
Page 136-137

Pano Prizi
/ Panel mounting socket
444.316.150



IP 44

120 gr.



Dik Kasalı Duvar Prizi
/ Wall mounting socket with straight box
444.316.151



IP 44

184 gr.



Eğik Kasalı Duvar Prizi
/ Wall mounting socket with angled box
444.316.152



IP 44

243 gr.



Kapaklı Seyyar Priz
/ Connector with cover
444.316.200

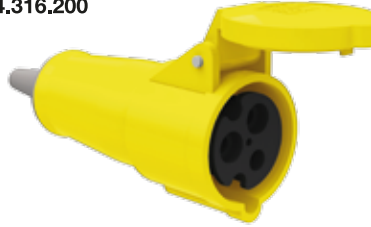

IP 44

124 gr.



Seyyar Fiş
/ Connector
444.316.300



IP 44

106 gr.



16A

6h

3Poles

2P+E

IP44

200-250 V~

Pano Prizi
/ Panel mounting socket
446.316.150



IP 44

118.5 gr.



Dik Kasalı Duvar Prizi
/ Wall mounting socket with straight box
446.316.151



IP 44

181 gr.



Eğik Kasalı Duvar Prizi
/ Wall mounting socket with angled box
446.316.152



IP 44

240 gr.



Eğik Kasalı Duvar Prizi + Schuko
/ Wall mounting socket with angled box+Schuko
446.316.153



IP 44

278 gr.



Kapaklı Seyyar Priz
/ Connector with cover
446.316.200



IP 44

127 gr.



Seyyar Fiş
/ Plug
446.316.300



IP 44

106 gr.



32A

6h

3Poles

2P+E

200-250 V~

Pano Prizi
/ Panel mounting socket
446.332.150



IP 44



Dik Kasalı Duvar Prizi
/ Wall mounting socket with straight box
446.332.151



IP 44



Eğik Duvar Prizi
/ Angled wall mounting socket
446.332.400



IP 44



Kapaklı Seyyar Priz
/ Connector with cover
446.332.200



IP 44



Seyyar Fiş
/ Connector
446.332.300



IP 44



Kilitli Kapaklı Pano Prizi
/ Panel mounting socket with locked cover
676.332.150



IP 67



Dik Kasalı Duvar Prizi
/ Wall mounting socket with straight box
676.332.151



IP 67



Kilitli Fiş
/ Plug with lock
676.332.300



IP 44



CEE NORM Fiş & Prizler / CEE Plugs & Sockets

16A

6h

4Poles

3P+E

380-415 V~

Pano Prizi
/ Panel mounting socket
446.416.150



IP 44



Pano Prizi
/ Panel mounting socket
446.416.160



IP 44



Dik Kasalı Duvar Prizi
/ Wall mounting socket with straight box
446.416.151



IP 44



Eğik Duvar Prizi
/ Angled wall mounting socket
446.416.152



IP 44



Eğik Kasalı Duvar Prizi + Schuko
/ Wall mounting socket with angled box+Schuko
446.416.153



IP 44



Kapaklı Seyyar Priz
/ Connector with cover
446.416.200



IP 44



Seyyar Priz
/ Connector
446.416.300



IP 44



Kilitli Kapaklı Pano Prizi
/ Panel mounting socket with locked cover
676.416.160



IP67



Kilitli Kapaklı Dik Kasalı Duvar Prizi
/ Wall mounting socket with straight box + locked cover
676.416.161



IP 67



Kilitli Kapaklı Seyyar Priz
/ Connector with locked cover
676.416.200



IP 44



Kilitli Seyyar Fiş
/ Plug with lock
676.416.300



IP 44



32A

6h

4Poles

3P+E

380-415 V~

Pano Prizi
/ Panel mounting socket
446.432.150



Dik Kasalı Duvar Prizi
/ Wall mounting socket with straight box
446.432.151



Eğik Duvar Prizi
/ Angled wall mounting socket
446.432.400



Kapaklı Seyyar Priz
/ Connector
446.432.200



Seyyar Fiş
/ Plug
446.432.300



Makine Fiş
/ Panel mounting inlet
446.432.330



Dik Kasalı Makine Fiş
/ Wall mounting inlet with straight box
446.432.331



Eğik Kasalı Makine Fiş
/ Wall mounting inlet with angled box
446.432.332



Eğik Kasalı Makine Fiş + Schuko
/ Wall mounting inlet with angled box+Schuko
446.432.333

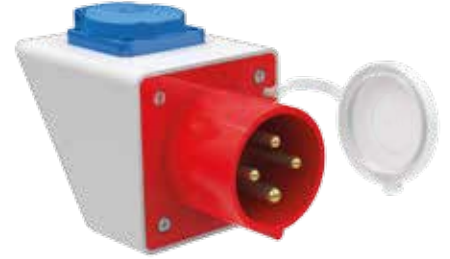

Kilitli Kapaklı Pano Prizi
/ Panel mounting socket with locked cover
676.432.150



Kilitli Kapaklı Dik Kasalı Duvar Prizi
/ Wall mounting socket with straight box and locked cover
676.432.151



Kilitli Seyyar Fiş
/ Plug with lock
676.432.300



CEE NORM Fiş & Prizler / CEE Plugs & Sockets

63A

6h

4Poles

3P+E(+Plt)

380-415 V~

Pano Prizi
/ Panel mounting socket
446.463.150



IP 44



569 gr.



6

Kapaklı Seyyar Priz
/ Connector
446.463.200



IP 44



625 gr.



6

Seyyar Fiş
/ Plug
446.463.300



IP 44



495 gr.



6

Kilitli Kapaklı Pano Prizi
/ Panel mounting socket with locked cover
676.463.150



IP 67



586 gr.



6

Kilitli Kapaklı Seyyar Priz
/ Connector with locked cover
676.463.200



IP67



665 gr.



6

Kilitli Seyyar Fiş
/ Plug with lock
676.463.300



IP67



530 gr.



6

16A

6h

5Poles

3P+N+E

IP44

380-415 V~

Pano Prizi
/ Panel mounting socket
446.516.150



Dik Kasalı Duvar Prizi
/ Wall mounting socket with straight box
446.516.151



Eğik Kasalı Duvar Prizi
/ Wall mounting socket with angled box
446.516.152



Eğik Kasalı Duvar Prizi + Schuko
/ Wall mounting socket with angled box+Schuko
446.516.153



Eğik Duvar Priz
/ Angled wall mounting socket
446.516.400



Seyyar Priz
/ Connector
446.516.200



Seyyar Fiş
/ Plug
446.516.300



Eğik Fiş
/ Angled plug
446.516.320



Makine Fiş
/ Panel mounting inlet
446.516.330

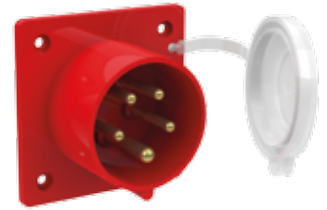

Dik Kasalı Makine Fiş
/ Wall mounting inlet with straight box
446.516.331

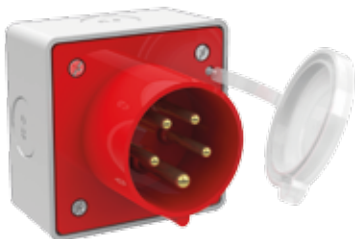

Eğik Kasalı Makine Fiş
/ Wall mounting inlet with angled box
446.516.332

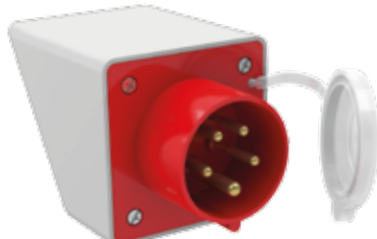

Eğik Kasalı Makine Fiş + Schuko
/ Wall mounting inlet with angled box+Schuko
446.516.333



16A

6h

5Poles

3P+N+E

IP67

380-415 V~

Kilitli Kapaklı Pano Prizi

/ Panel mounting socket with locked cover
676.516.150



IP 67



Kilitli Kapaklı Dik Kasalı Duvar Prizi

/ Wall mounting socket with straight box and locked cover
676.516.151



IP67



Kilitli Kapaklı Eğik Kasalı Duvar Prizi
/ Wall mounting socket with angled box
and locked cover
676.516.152



IP67



Kilitli Kapaklı Eğik Kasalı Duvar Prizi + Schuko
/ Wall mounting socket with angled box
and locked cover+Schuko
676.516.153



IP67



Kilitli Seyyar Fiş
/ Plug with lock
676.516.300



IP44



32A

6h

5Poles

3P+N+E

380-415 V~

Pano Prizi
/ Panel mounting socket
446.532.150



IP 44



Dik Kasalı Duvar Prizi
/ Wall mounting socket with straight box
446.532.151



IP44



Seyyar Priz
/ Connector
446.532.200



IP 44



Seyyar Fiş
/ Plug
446.532.300



IP 44



Makine Fiş
/ Panel mounting inlet
446.532.330

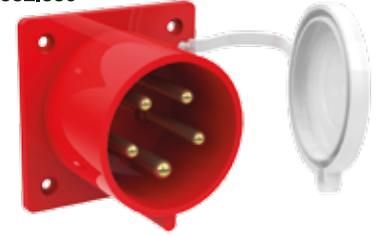

IP 44



Dik Kasalı Makine Fiş
/ Wall mounting inlet with straight box
446.532.331

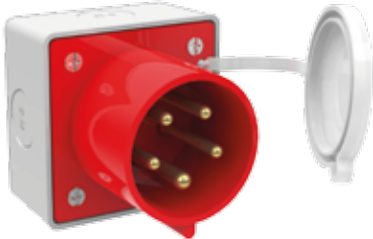

IP 44



Eğik Kasalı Makine Fiş
/ Wall mounting inlet with angled box
446.532.332

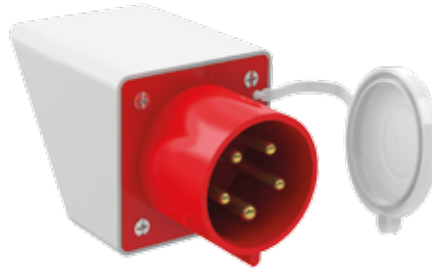

IP 44



Eğik Kasalı Makine Fiş + Schuko
/ Wall mounting inlet with angled box+Schuko
446.532.333



IP44



Kilitli Kapaklı Pano Prizi
/ Panel mounting socket with locked cover
676.532.150



IP 67



Kilitli Kapaklı Dik Kasalı Duvar Prizi
/ Wall mounting socket with straight box and locked cover
676.532.151



IP 67



Kilitli Seyyar Fiş
/ Plug with lock
676.532.300



IP 44



63A

6h

5Poles

3P+N+E(+Plt)

380-415 V~

Pano Prizi
/ Panel mounting socket
446.563.150



IP 44



Kilitli Seyyar Priz
/ Connector with cover
446.563.200



IP 44



Seyyar Fiş
/ Plug
446.563.300



IP 44



Kilitli Kapaklı Pano Prizi
/ Panel mounting socket with locked cover
676.563.150



IP 67



Kilitli Kapaklı Seyyar Priz
/ Connector with locked cover
676.563.200



IP67



Kilitli Seyyar Fiş
/ Plug with lock
676.563.300



IP67



6h

Seyyar 3'lü Çoklayıcı Prizler / 3Way Multiplier Sockets

50-60 Hz.

Rekor Girişili 3'lü Prizler
/ Gland Entry 3 Way Sockets



IP44	Ref Code	A	P	VOLT	
	1344.316.333.1	16	2P+T	200-250	2
	1344.332.333.1	32	2P+T	200-250	4
	1344.416.333.1	16	3P+T	380-415	2
	1344.432.333.1	32	3P+T	380-415	2
	1344.516.333.1	16	3P+N+T	380-415	2
	1344.532.333.1	32	3P+N+T	380-415	2

Fiş Girişili 3'lü Prizler
/ Plug Entry 3 Way Sockets



IP44	Ref Code	A	P	VOLT	
	1344.316.333.0	16	2P+T	200-250	2
	1344.332.333.0	32	2P+T	200-250	4
	1344.416.333.0	16	3P+T	380-415	2
	1344.432.333.0	32	3P+T	380-415	2
	1344.516.333.0	16	3P+N+T	380-415	2
	1344.532.333.0	32	3P+N+T	380-415	2

Rekor Girişili 3'lü Prizler
/ Gland Entry 3 Way Sockets



IP67	Ref Code	A	P	VOLT	
	1367.316.333.1	16	2P+T	200-250	2
	1367.332.333.1	32	2P+T	200-250	4
	1367.416.333.1	16	3P+T	380-415	2
	1367.432.333.1	32	3P+T	380-415	2
	1367.516.333.1	16	3P+N+T	380-415	2
	1367.532.333.1	32	3P+N+T	380-415	2

Fiş Girişili 3'lü Prizler
/ Plug Entry 3 Way Sockets



IP67	Ref Code	A	P	VOLT	
	1367.316.333.0	16	2P+T	200-250	2
	1367.332.333.0	32	2P+T	200-250	4
	1367.416.333.0	16	3P+T	380-415	2
	1367.432.333.0	32	3P+T	380-415	2
	1367.516.333.0	16	3P+N+T	380-415	2
	1367.532.333.0	32	3P+N+T	380-415	2

6h

Pano Prizler / Panel Mounting Sockets

50-60 Hz.

75x75 Dik Pano Prizler

/ 75x75 Straight Panel Mounting Sockets



IP44	Ref Code	A	P	VOLT	
	446.316.180	16	2P+T	200-250	10
	446.332.180	32	2P+T	200-250	5
	446.416.180	16	3P+T	380-415	10
	446.432.180	32	3P+T	380-415	5
	446.516.180	16	3P+N+T	380-415	8
	446.532.180	32	3P+N+T	380-415	5

Eğik Pano Prizler

/ Angled Mounting Sockets



IP44	Ref Code	A	P	VOLT	
	446.316.190	16	2P+T	200-250	10
	446.332.190	32	2P+T	200-250	5
	446.416.190	16	3P+T	380-415	10
	446.432.190	32	3P+T	380-415	5
	446.516.190	16	3P+N+T	380-415	8
	446.532.190	32	3P+N+T	380-415	5

Kilitli Kapaklı Dik Pano Prizler

/ Straight Panel Mounting Sockets with Locked Cover



IP67	Ref Code	A	P	VOLT	
	676.316.180	16	2P+T	200-250	8
	676.332.180	32	2P+T	200-250	5
	676.416.180	16	3P+T	380-415	8
	676.432.180	32	3P+T	380-415	5
	676.516.180	16	3P+N+T	380-415	8
	676.532.180	32	3P+N+T	380-415	5

Kilitli Kapaklı Eğik Pano Prizler

/ Angled Panel Mounting Sockets with Locked Cover



IP67	Ref Code	A	P	VOLT	
	676.316.190	16	2P+T	200-250	10
	676.332.190	32	2P+T	200-250	5
	676.416.190	16	3P+T	380-415	8
	676.432.190	32	3P+T	380-415	5
	676.516.190	16	3P+N+T	380-415	8
	676.532.190	32	3P+N+T	380-415	5

6h

Duvar Prizler / Wall Mounting Sockets

50-60 Hz.

Dik Duvar Prizler

/ Straight Wall Mounting Sockets



IP44	Ref Code	A	P	VOLT	
	446.316.410	16	2P+T	200-250	3
	446.332.410	32	2P+T	200-250	2
	446.416.410	16	3P+T	380-415	3
	446.432.410	32	3P+T	380-415	2
	446.516.410	16	3P+N+T	380-415	3
	446.532.410	32	3P+N+T	380-415	2

Kilitli Kapaklı Eğik Duvar Prizler

/ Angled Wall Mounting Sockets with Locked Cover



IP67	Ref Code	A	P	VOLT	
	676.316.410	16	2P+T	200-250	3
	676.332.410	32	2P+T	200-250	2
	676.416.410	16	3P+T	380-415	3
	676.432.410	32	3P+T	380-415	2
	676.516.410	16	3P+N+T	380-415	3
	676.532.410	32	3P+N+T	380-415	2

6h

Pano Prizler / Panel Mounting Sockets

50-60 Hz.

Kapaklı Seyyar Prizler
/ Connectors with Cover



IP44	Ref Code	A	P	VOLT	
	446.316.240	16	2P+T	200-250	10
	446.332.240	32	2P+T	200-250	4
	446.416.240	16	3P+T	380-415	10
	446.432.240	32	3P+T	380-415	4
	446.516.240	16	3P+N+T	380-415	5
	446.532.240	32	3P+N+T	380-415	3

Seyyar Fiş
/ Plugs



IP44	Ref Code	A	P	VOLT	
	446.316.340	16	2P+T	200-250	10
	446.332.340	32	2P+T	200-250	5
	446.416.340	16	3P+T	380-415	10
	446.432.340	32	3P+T	380-415	5
	446.516.340	16	3P+N+T	380-415	8
	446.532.340	32	3P+N+T	380-415	4

Kilitli Kapaklı Seyyar Prizler
/ Connectors with Cover with Locked Cover



IP67	Ref Code	A	P	VOLT	
	676.316.240	16	2P+T	200-250	10
	676.332.240	32	2P+T	200-250	4
	676.416.240	16	3P+T	380-415	8
	676.432.240	32	3P+T	380-415	4
	676.516.240	16	3P+N+T	380-415	4
	676.532.240	32	3P+N+T	380-415	3

Kilitli Seyyar Fiş
/ Plugs with Locked Cover



IP67	Ref Code	A	P	VOLT	
	676.316.340	16	2P+T	200-250	10
	676.332.340	32	2P+T	200-250	4
	676.416.340	16	3P+T	380-415	8
	676.432.340	32	3P+T	380-415	4
	676.516.340	16	3P+N+T	380-415	6
	676.532.340	32	3P+N+T	380-415	3

6h

İçten Kilitli Şalterli Prizler / Sockets with Internal Locked Switches

50-60 Hz.

Yatay Pano Prizler

/ Horizontal Panel Mounting Sockets



IP44	Ref Code	A	P	VOLT	
	1444.316.15	16	2P+T	200-250	1
	1444.332.15	32	2P+T	200-250	1
	1444.416.15	16	3P+T	380-415	1
	1444.432.15	32	3P+T	380-415	1
	1444.516.15	16	3P+N+T	380-415	1
	1444.532.15	32	3P+N+T	380-415	1

Yatay Kilitli Pano Prizler

/ Horizontal Panel Mounting Sockets with Locked Cover



IP67	Ref Code	A	P	VOLT	
	1467.316.15	16	2P+T	200-250	1
	1467.332.15	32	2P+T	200-250	1
	1467.416.15	16	3P+T	380-415	1
	1467.432.15	32	3P+T	380-415	1
	1467.516.15	16	3P+N+T	380-415	1
	1467.532.15	32	3P+N+T	380-415	1

Yatay Duvar Prizler

/ Horizontal Wall Mounting Sockets



IP44	Ref Code	A	P	VOLT	
	1444.316.10	16	2P+T	200-250	1
	1444.332.10	32	2P+T	200-250	1
	1444.416.10	16	3P+T	380-415	1
	1444.432.10	32	3P+T	380-415	1
	1444.516.10	16	3P+N+T	380-415	1
	1444.532.10	32	3P+N+T	380-415	1

Yatay Kilitli Duvar Prizler

/ Horizontal Wall Mounting Sockets with Locked Cover



IP67	Ref Code	A	P	VOLT	
	1467.316.10	16	2P+T	200-250	1
	1467.332.10	32	2P+T	200-250	1
	1467.416.10	16	3P+T	380-415	1
	1467.432.10	32	3P+T	380-415	1
	1467.516.10	16	3P+N+T	380-415	1
	1467.532.10	32	3P+N+T	380-415	1

6h

İçten Kilitli Şalterli Prizler / Sockets with Internal Locked Switches

50-60 Hz.

Dikey Pano Prizler

/ Vertical Panel Mounting Sockets



IP44	Ref Code	A	P	VOLT	
	1944.316.15	16	2P+T	200-250	1
	1944.332.15	32	2P+T	200-250	1
	1944.416.15	16	3P+T	380-415	1
	1944.432.15	32	3P+T	380-415	1
	1944.516.15	16	3P+N+T	380-415	1
	1944.532.15	32	3P+N+T	380-415	1

Dikey Pano Prizler

/ Vertical Panel Mounting Sockets



IP44	Ref Code	A	P	VOLT	
	1967.316.15	16	2P+T	200-250	1
	1967.332.15	32	2P+T	200-250	1
	1967.416.15	16	3P+T	380-415	1
	1967.432.15	32	3P+T	380-415	1
	1967.516.15	16	3P+N+T	380-415	1
	1967.532.15	32	3P+N+T	380-415	1

Dikey Duvar Prizler

/ Vertical Wall Mounting Sockets



IP67	Ref Code	A	P	VOLT	
	1944.316.10	16	2P+T	200-250	1
	1944.332.10	32	2P+T	200-250	1
	1944.416.10	16	3P+T	380-415	1
	1944.432.10	32	3P+T	380-415	1
	1944.516.10	16	3P+N+T	380-415	1
	1944.532.10	32	3P+N+T	380-415	1

Dikey Duvar Prizler

/ Vertical Wall Mounting Sockets



IP67	Ref Code	A	P	VOLT	
	1967.316.10	16	2P+T	200-250	1
	1967.332.10	32	2P+T	200-250	1
	1967.416.10	16	3P+T	380-415	1
	1967.432.10	32	3P+T	380-415	1
	1967.516.10	16	3P+N+T	380-415	1
	1967.532.10	32	3P+N+T	380-415	1

6h İçten Kilitli Şalterli Prizler / Sockets with Internal Locked Switches & MCB 50-60 Hz.

Pano Prizler
/ Panel Mounting Sockets



IP44	Ref Code	A	P	VOLT	
	1644.316.15	16	2P+T	200-250	1
	1644.332.15	32	2P+T	200-250	1
	1644.416.15	16	3P+T	380-415	1
	1644.432.15	32	3P+T	380-415	1
	1644.516.15	16	3P+N+T	380-415	1
	1644.532.15	32	3P+N+T	380-415	1

Pano Kilitli Prizler
/ Panel Mounting Sockets
with Locked Cover



IP67	Ref Code	A	P	VOLT	
	1667.316.15	16	2P+T	200-250	1
	1667.332.15	32	2P+T	200-250	1
	1667.416.15	16	3P+T	380-415	1
	1667.432.15	32	3P+T	380-415	1
	1667.516.15	16	3P+N+T	380-415	1
	1667.532.15	32	3P+N+T	380-415	1

Duvar Prizler
/ Wall Mounting Sockets



IP44	Ref Code	A	P	VOLT	
	1644.316.10	16	2P+T	200-250	1
	1644.332.10	32	2P+T	200-250	1
	1644.416.10	16	3P+T	380-415	1
	1644.432.10	32	3P+T	380-415	1
	1644.516.10	16	3P+N+T	380-415	1
	1644.532.10	32	3P+N+T	380-415	1

Duvar Kilitli Prizler
/ Wall Mounting Sockets
with Locked Cover



IP67	Ref Code	A	P	VOLT	
	1667.316.10	16	2P+T	200-250	1
	1667.332.10	32	2P+T	200-250	1
	1667.416.10	16	3P+T	380-415	1
	1667.432.10	32	3P+T	380-415	1
	1667.516.10	16	3P+N+T	380-415	1
	1667.532.10	32	3P+N+T	380-415	1

TEM®

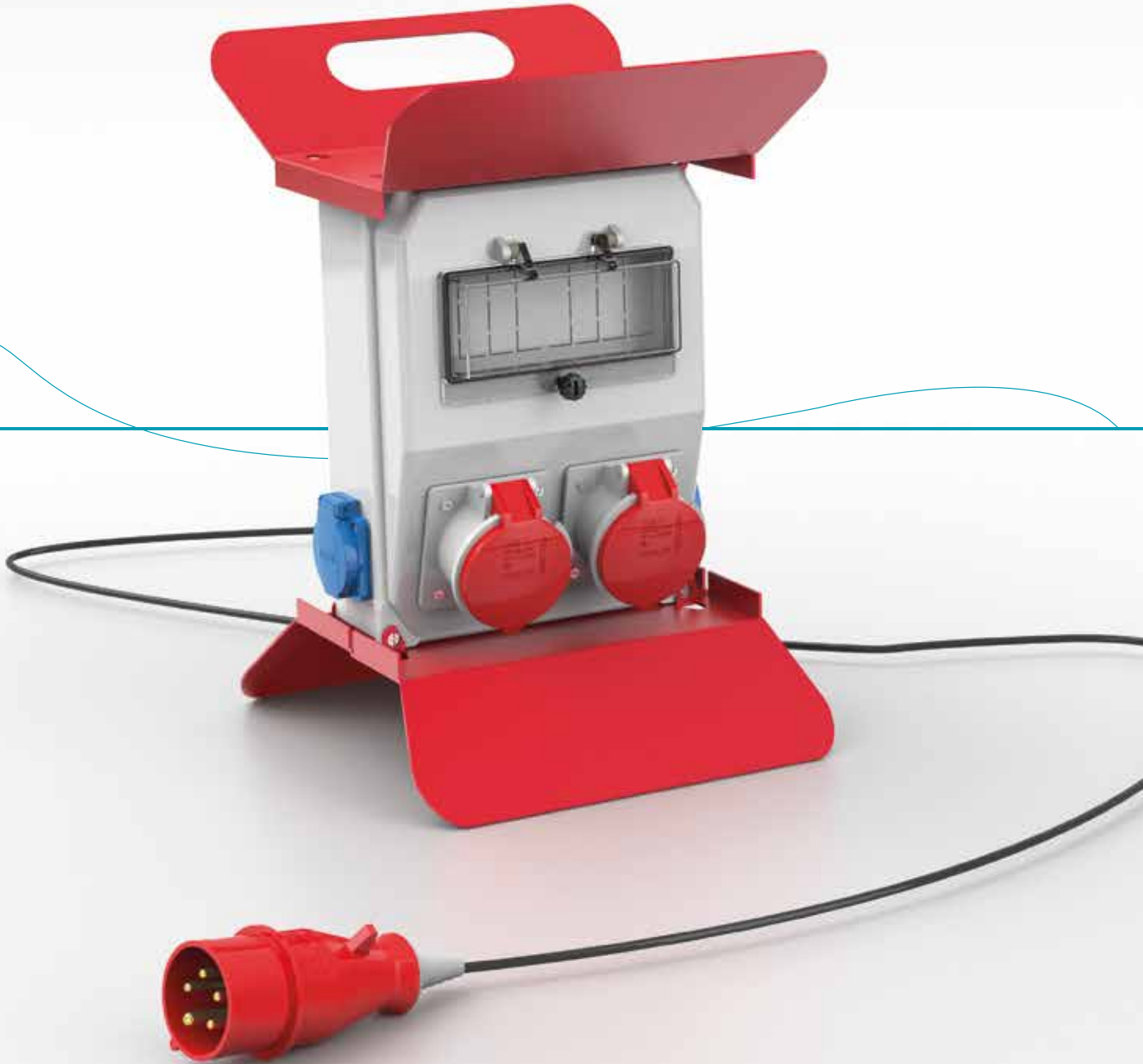

KOMBİNASYON KUTULARI
Combination Boxes

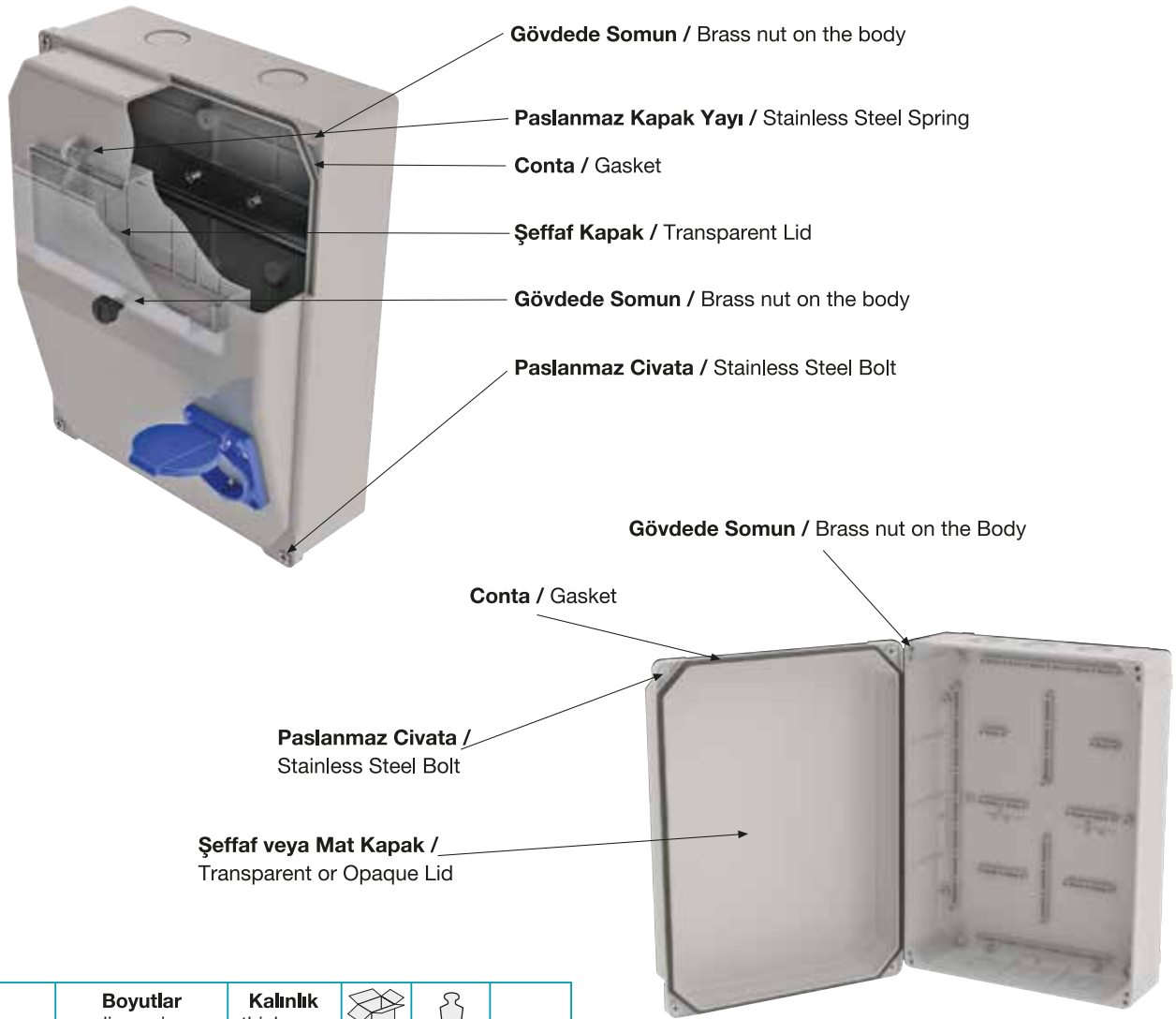

Ref. Code	Boyutlar dimension			Kalınlık thickness			IP
	mm	mm	mm				
451	260	350	120	2 - 3	1	1275	67
452	210	280	100	2,5 - 3	1	840	67
453	113	210	90	2 - 2,5	3	340	67
463	135	250	120	2 - 2,5	3	450	67
461	260	350	118	2 - 3	1	1350	67
454	113	210	73	2 - 2,5	6	305	44
455	210	280	100	2 - 3	1	670	67

- Isıya dayanım seviyesi is V2.

Heat resistance level is V2.

- IEC 60309-1 ve IEC 60695-2-1 uygundur.

It qualified by IEC 60309-1 and IEC 60695-2-1 standards.

- kullanım sıcaklığı en az -25 °C ve en fazla +60 °C olur.

Installation temprature in minimum is -25 °C and in maximum is +60 °C.

Kombinasyon Kutuları / Combination Boxes

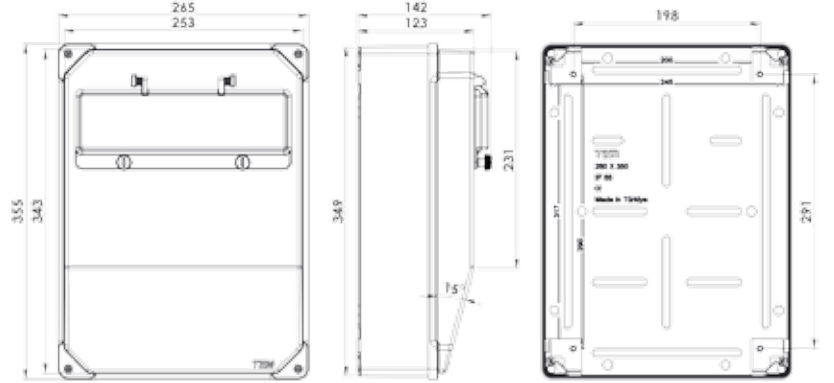

26x35 KUTULARI / BOXES

Ref Code: 451.0012.0000.000

265 x 355 x 142 mm

10.4 x 14 x 5.6 inch

451.0000.4160.028



4x16A CEE Socket IP44 2pcs.
1x16A Schuko Socket IP67 8pcs.

451.4160.3160.224



4x16A CEE Socket IP44 2pcs.
3x16A CEE Socket IP44 2pcs.
1x16A Schuko Socket IP44 4pcs.

451.3320.3160.224



3x32A CEE Socket IP44 2pcs.
3x16A CEE Socket IP44 2pcs.
1x16A Schuko Socket IP44 4pcs.

451.4160.4320.224



4x16A CEE Socket IP44 2pcs.
4x32A CEE Socket IP44 2pcs.
1x16A Schuko Socket IP44 4pcs.

451.5320.5160.224



5x32A CEE Socket IP44 2pcs.
5x16A CEE Socket IP44 2pcs.
1x16A Schuko Socket IP44 4pcs.

451.0000.5321.040



5x32A CEE Socket IP67 4pcs.

451.3321.5321.220



3x32A CEE Socket IP67 2pcs.
5x32A CEE Socket IP67 2pcs.

451.4321.5321.220



4x32A CEE Socket IP67 2pcs.
5x32A CEE Socket IP67 2pcs.

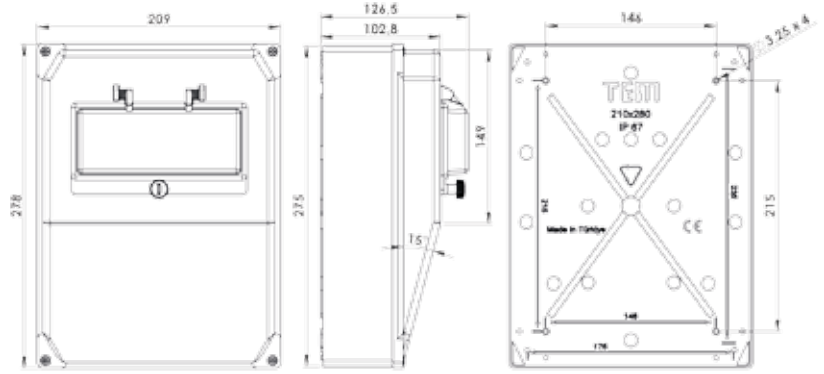

21x28 KUTULARI / BOXES

Ref Code: 452.0008.0000.000

209 x 278 x 126 mm

8.2 x 10.9 x 5 inch

452.0000.3160.022



3x16A CEE Socket IP44 2pcs.
1x16A Schuko Socket IP44 2pcs.

452.0000.4160.022



4x16A CEE Socket IP44 2pcs.
1x16A Schuko Socket IP44 2pcs.

452.0000.5160.022



5x16A CEE Socket IP44 2pcs.
1x16A Schuko Socket IP44 2pcs.

452.0000.4320.022



4x32A CEE Socket IP44 2pcs.
1x16A Schuko Socket IP44 2pcs.

452.0000.5320.022



5x32A CEE Socket IP44 2pcs.
2x16A Schuko Socket IP44 2pcs.

452.0000.5321.040



5x32A CEE Socket IP67 2pcs.

452.3321.4321.110



3x32A CEE Socket IP67 1pcs.
4x32A CEE Socket IP67 1pcs.

452.0000.5321.020



5x32A CEE Socket IP67 2pcs.

Kombinasyon Kutuları / Combination Boxes

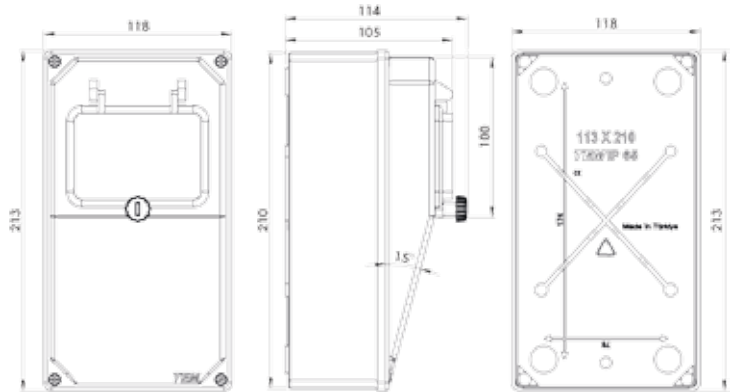

11x21 KUTULARI / BOXES

Ref Code: 453.0004.0000.000

118 x 213 x 114 mm

4.6 x 8.4 x 4.5 inch

453.0000.3160.012



3x16A CEE Socket IP44 1pcs.
1x16A Schuko Socket IP44 2pcs.

453.0000.4160.012



4x16A CEE Socket IP44 1pcs.
1x16A Schuko Socket IP44 2pcs.

453.0000.5160.012



5x16A CEE Socket IP44 1pcs.
1x16A Schuko Socket IP44 2pcs.

453.0000.3320.012



3x32A CEE Socket IP44 1pcs.
1x16A Schuko Socket IP44 2pcs.

453.0000.5320.012



5x32A CEE Socket IP44 1pcs.
1x16A Schuko Socket IP44 2pcs.

453.0000.3321.010



3x32A CEE Socket IP67 1pcs.

453.0000.4321.010



4x32A CEE Socket IP67 1pcs.

453.0000.5321.010



5x32A CEE Socket IP67 1pcs.

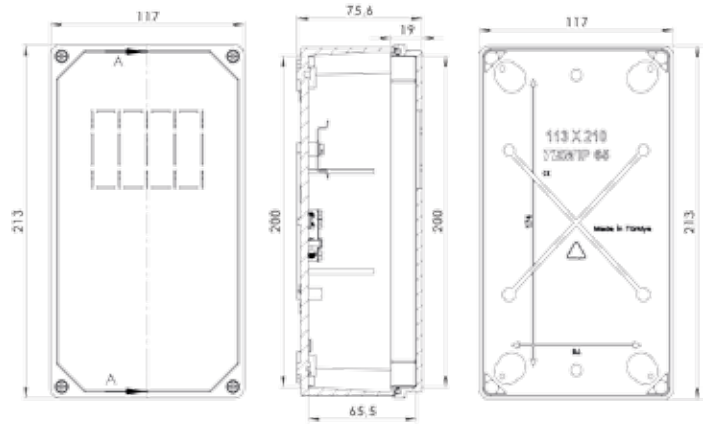

11x21 KUTULARI / BOXES

Ref Code: 454.0004.0000.000

117 x 213 x 75 mm

4.6 x 8.4 x 2.9 inch

454.0000.3160.012



3x16A CEE Socket IP44 1pcs.
1x16A Schuko Socket IP44 2pcs.

454.0000.4160.012



4x16A CEE Socket IP44 1pcs.
1x16A Schuko Socket IP44 2pcs.

454.0000.5160.012



5x16A CEE Socket IP44 1pcs.
1x16A Schuko Socket IP44 2pcs.

454.0000.3320.012



3x32A CEE Socket IP44 1pcs.
1x16A Schuko Socket IP44 2pcs.

454.0000.5320.012



5x32A CEE Socket IP44 1pcs.
1x16A Schuko Socket IP44 2pcs.

454.0000.3321.010



3x32A CEE Socket IP67 1pcs.

454.0000.4321.010



4x32A CEE Socket IP67 1pcs.

453.0000.5321.010



5x32A CEE Socket IP67 1pcs.

Kombinasyon Kutuları / Combination Boxes

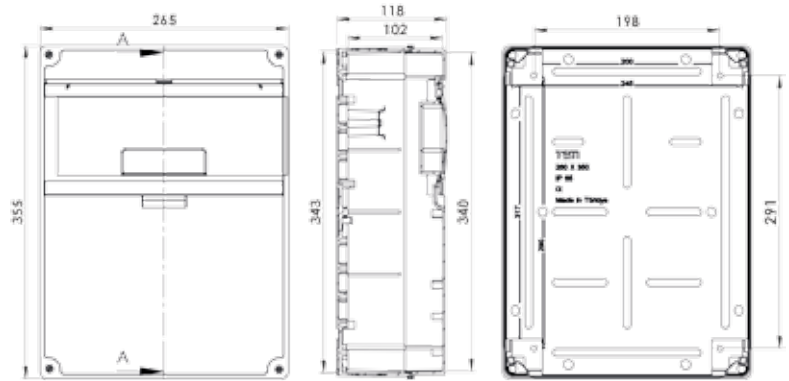

26x35 KUTULARI / BOXES

Ref Code: 461.0012.0000.000

265 x 355 x 118 mm

10.4 x 14 x 4.6 inch

461.0000.4160.028



4x16A CEE Socket IP44 2pcs.
1x16A Schuko Socket IP44 8pcs.

461.4160.3160.224



4x16A CEE Socket IP44 2pcs.
3x16A CEE Socket IP44 2pcs.
1x16A Schuko Socket IP44 4pcs.

461.3320.3160.224



3x32A CEE Socket IP44 2pcs.
3x16A CEE Socket IP44 2pcs.
1x16A Schuko Socket IP44 4pcs.

451.4160.4320.224



4x16A CEE Socket IP44 2pcs.
4x32A CEE Socket IP44 2pcs.
1x16A Schuko Socket IP44 4pcs.

461.5320.5160.224



5x32A CEE Socket IP44 2pcs.
5x16A CEE Socket IP44 2pcs.
1x16A Schuko Socket IP44 4pcs.

451.0000.5630.028



5x63A CEE Socket IP44 2pcs.
1x16A Schuko Socket IP44 8pcs.

451.0000.3321.024



3x32A CEE Socket IP67 2pcs.
1x16A Schuko Socket IP44 4pcs.

461.0000.5321.024



5x32A CEE Socket IP67 2pcs.
1x16A Schuko Socket IP44 4pcs.

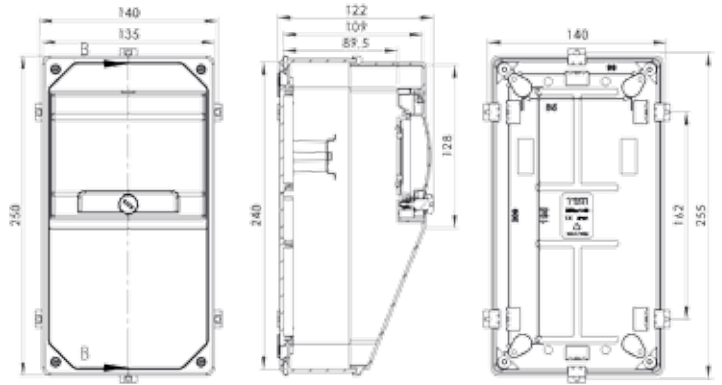

11x21 KUTULARI / BOXES

Ref Code: 463.0006.0000.000

135 x 250 x 122 mm

5.3 x 9.8 x 4.8 inch

463.0000.3160.012



3x16A CEE Socket IP44 1pcs.
1x16A Schuko Socket IP44 2pcs.

463.0000.4160.012



4x16A CEE Socket IP44 1pcs.
1x16A Schuko Socket IP44 2pcs.

463.0000.5160.012



5x16A CEE Socket IP44 1pcs.
1x16A Schuko Socket IP44 2pcs.

463.0000.3320.012



3x32A CEE Socket IP44 1pcs.
1x16A Schuko Socket IP44 2pcs.

463.0000.4320.012



4x32A CEE Socket IP44 1pcs.
1x16A Schuko Socket IP44 2pcs.

463.0000.3321.010



3x32A CEE Socket IP67 1pcs.

463.0000.4321.010



4x32A CEE Socket IP67 1pcs.

463.0000.5321.010



5x32A CEE Socket IP67 1pcs.

Kombinasyon Kutuları / Combination Boxes

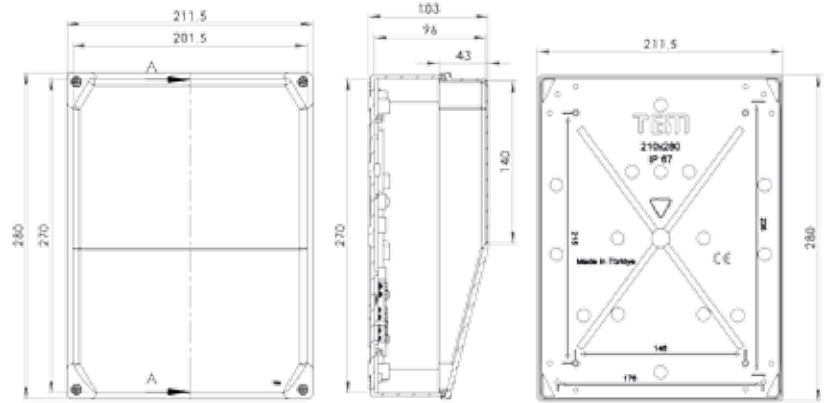

21x28 KUTULARI / BOXES

Ref Code: 455.0000.0000.000

211 x 280 x 103 mm

8.3 x 11 x 4 inch

455.0000.4160.028



4x16A CEE Socket IP44 2pcs.
1x16A Schuko Socket IP67 8pcs.

455.4160.3160.224



4x16A CEE Socket IP44 2pcs.
3x16A CEE Socket IP44 2pcs.
1x16A Schuko Socket IP44 4pcs.

455.4160.4320.224



4x16A CEE Socket IP44 2pcs.
4x32A CEE Socket IP44 2pcs.
1x16A Schuko Socket IP44 4pcs.

455.0000.5320.024



5x32A CEE Socket IP44 2pcs.
1x16A Schuko Socket IP44 4pcs.

455.5320.5160.224



5x32A CEE Socket IP44 2pcs.
5x16A CEE Socket IP44 2pcs.
1x16A Schuko Socket IP44 4pcs.

455.0000.5321.040



5x32A CEE Socket IP67 4pcs.

455.3321.5321.220



3x32A CEE Socket IP67 2pcs.
5x32A CEE Socket IP67 2pcs.

455.4321.5321.220



4x32A CEE Socket IP67 2pcs.
5x32A CEE Socket IP67 2pcs.

Özel Kombinasyon Kutular Örneği Sample of Combination Boxes



ON/OFF Switch 1pcs.
Pako Switch 1pcs.



ON/OFF Switch 1pcs.
1x16A Schuko Socket IP44 4pcs.



3x32A CEE Socket IP44 1pcs.
1x16A Schuko Socket IP44 1pcs.



Fuse 1pcs.
ON/OFF Switch 1pcs.
3x16A CEE Socket IP44 1pcs.
1x16A Schuko Socket IP44 1pcs.



5x16A CEE Socket IP44 2pcs.
1x16A Schuko Socket IP44 2pcs.



Pako Switch 2pcs.
1x16A Schuko Socket IP44 4pcs.



3x32A CEE Socket IP44 2pcs.
1x16A Schuko Socket IP44 4pcs.



3x16A CEE Socket IP44 2pcs.
5x16A CEE Socket IP44 2pcs.
1x16A Schuko Socket IP44 3pcs.



5x16A CEE Socket IP67 2pcs.
5x63A CEE Socket IP67 2pcs.
1x16A Schuko Socket IP44 4pcs.

Kombinasyon Kutular & Termoplastik Buatlar Aksesuarı Combination Boxes & Thermoplastic Enclosures Accessories



Çatı / Roof
740.030.100

Ayak / Stand
740.020.100

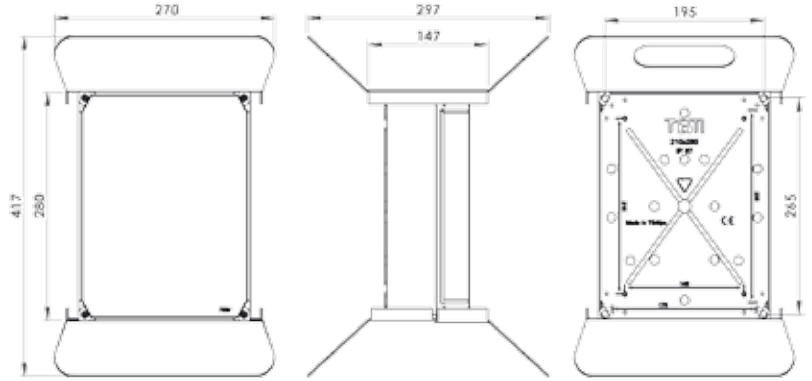

21x28x10 Kombinasyon Kutu / Combination Box
455.4321.5321.220
740.030.100
740.020.100



4x32A CEE Socket IP67 2pcs.
5x32A CEE Socket IP67 2pcs.

21x28x13 Kombinasyon Kutu / Combination Box
452.0000.5160.022
740.030.100
740.020.100



5x16A CEE Socket IP44 2pcs.
1x16A Schuko Socket IP44 2pcs.

21x28x10 Buat / Enclosure
300.100.500.516.024
740.030.100
740.020.100



5x16A CEE Socket IP44 2pcs.
1x16A Schuko Socket IP44 4pcs.

21x28x13 Buat / Enclosure
400.135.600.5321.5631.224
740.030.100
740.010.100



5x16A CEE Socket IP67 2pcs.
5x63A CEE Socket IP67 2pcs.
1x16A Schuko Socket IP44 4pcs.

Kombinasyon Kutular & Termoplastik Buatlar Aksesuarı Combination Boxes & Thermoplastic Enclosures Accessories



30x60 TAŞIYICI AYAK / POD-FEET

Ref Code: 740.022.001

310 x 610 x 330 mm

12.2 x 24.4 x 13 inch

Taşıyıcıya monte edilebilir ürünler / for the products below:

- 21x28 - 26x35 Kombinasyon Kutular / Combination Boxes
- 21x28 - 26x35 Termoplastik Buatlar / Thermoplastic Enclosures
- 26x35 Dağıtım Panolar / Distribution Boards

21x28x13 Kutu / Box
452.0000.3160.022
740.022.001



21x28x10 Kutu / Box
455.4321.5321.220
740.022.001



26x35x14 Kutu / Box
451.0000.4160.028
740.022.001



26x35x12 Kutu / Box
461.0000.4160.028
740.022.001



21x28x10 Buat / Enclosure
300.100.500.3320.024
740.022.001



21x28x14 Buat / Enclosure
400.135.600.5321.5631.224
740.022.001



26x35x12 Buat / Enclosure
300.115.500.3160.4320.223
740.022.001



26x35x15 Buat / Enclosure
400.155.600.3321.4321.223
740.022.001



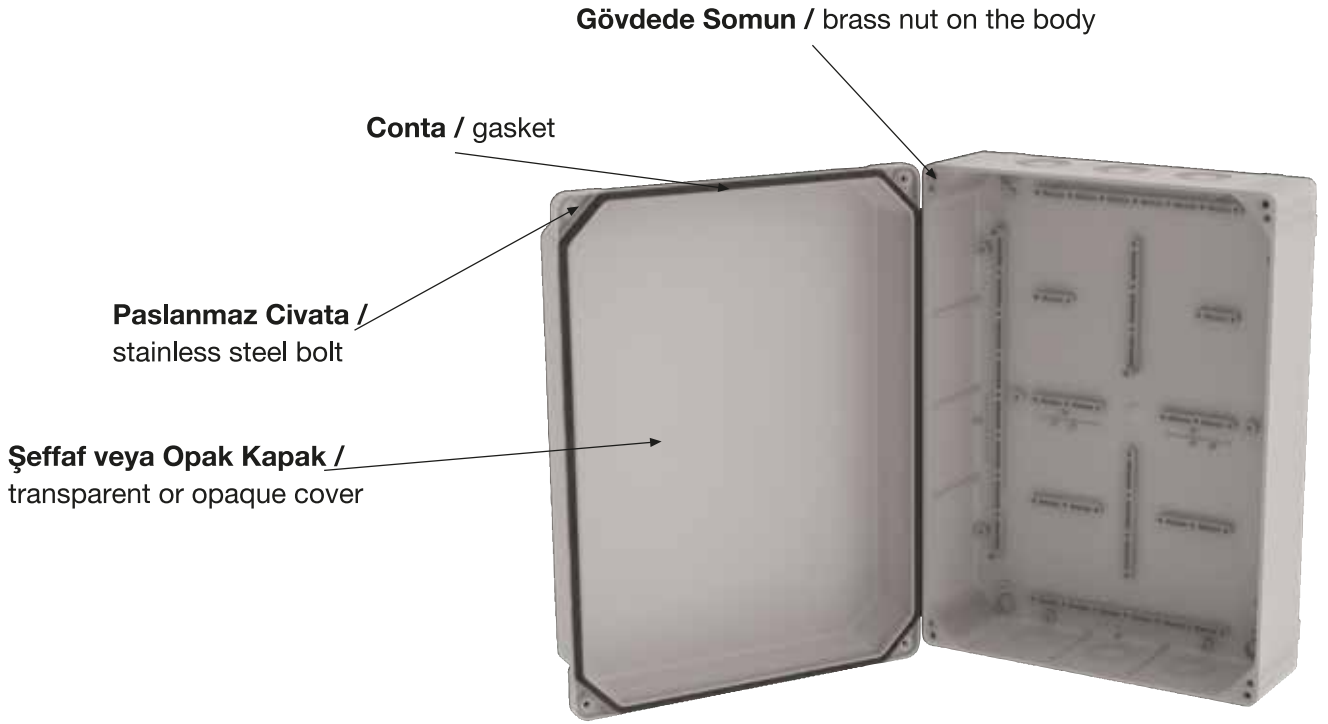

Özel üretim termoplastik buatlar

Special examples for outdoor thermoplastic enclosures



- **Isıya dayanım seviyesi is V2.**
Heat resistance level is V2.
- **IEC 60309-1 ve IEC 60695-2-1 uygundur.**
It qualified by IEC 60309-1 and IEC 60695-2-1 standards.
- **kullanım sıcaklığı en az -25 °C ve en fazla +60 °C olur.**
Installation temprature in minime is -25 °C and in maximum is +60 °C.

Termoplastik Buatlar Teknik Detaylar Thermoplastic Enclosures Technical Details

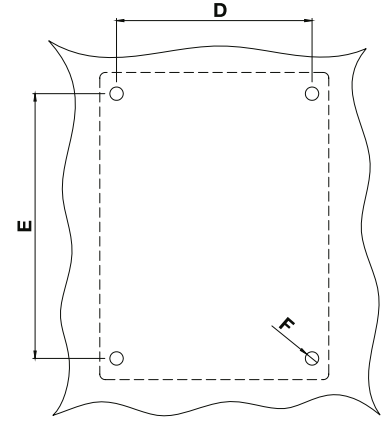
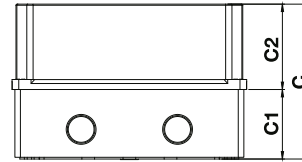
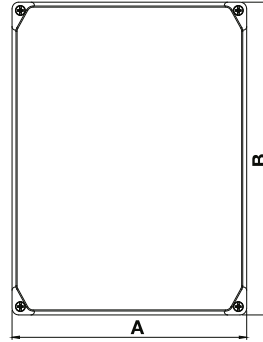

Duvara Montaj Ölçüleri

Ref. Code		Diş / External					İç / Internal			Duvar Montaj Wall Mounting		
Opak Kapak Opaque Cover	Şeffaf Kapak Transparent Cover	A	B	C	C1	C2	A	B	C	D	E	F
380.041.100	-	85	85	41	40.5	6	80	80	42	55	-	10
400.055.300	400.055.305	95	95	55	49,5	5.5	86.5	86.5	49	99	-	4
400.120.310	400.120.315	113	113	120	58	67	109	109	119	78	78	12
400.073.300	400.073.305	113	113	73	58	18	108.5	108.5	70	78	78	12
400.073.400	400.073.405	113	210	73	58	18	108.5	205	70	78	174	12
400.120.410	400.120.415	113	210	120	55	70	108.5	205	120	78	174	12
400.085.420	400.085.425	130	245	85	62	22	125	240	77.5	85	195	12
400.140.420	400.140.425	130	245	140	62	78	125	240	132.5	85	195	12
400.100.500	400.100.505	210	280	100	62	41	200	270	97	175	237	12
400.135.600	400.135.605	210	280	135	62	76.5	200	270	129.5	175	237	12
400.115.500	400.115.505	260	350	115	74	48	253	343	115	198	318	12
400.155.600	400.155.605	260	350	155	74	83	253	343	150	198	318	12
400.150.700	400.150.705	265	355	153	105	48	253	343	146	198	318	12
400.185.700	400.185.705	265	355	186	103	83	253	343	179	198	318	12

Termoplastik Buatlar / Thermoplastic Enclosures



Opak kapaklı termoplastik buatlar (Halojen Gazi İçermez) Opaque cover thermoplastic enclosures (Halojen Free)



400.073.300



300.135.600

Ref. Code		Dış Ölçüler External Dimension		 gr.
IP44	IP67			
380.041.100	-	85 x 85 x 41	24	71
300.055.300	400.055.300	95 x 95 x 55	6	00
300.120.310	400.120.310	113 x 113 x 120	6	177
300.073.300	400.073.300	113 x 113 x 73	12	157
300.073.400	400.073.400	113 x 210 x 73	6	272
300.120.410	400.120.410	117 x 210 x 120	3	354
300.085.420	400.085.420	130 x 245 x 85	2	368
300.140.420	400.140.420	130 x 245 x 140	2	458
300.100.500	400.100.500	210 x 280 x 100	1	719
300.135.600	400.135.600	210 x 280 x 135	1	861
300.115.500	400.115.500	260 x 350 x 115	1	1102
300.155.600	400.155.600	260 x 350 x 155	1	1192
300.150.700	400.150.700	265 x 355 x 153	1	1180
300.185.700	400.185.700	265 x 355 x 186	1	1270



Şeffaf kapaklı termoplastik buatlar (Halojen Free) Transparent cover thermoplastic enclosures (Halojen Free)



300.100.505



300.135.600

Ref. Code		Dış Ölçüler External Dimension		 gr.
IP44	IP67			
300.055.305	400.055.305	95 x 95 x 55	6	00
300.120.315	400.120.315	113 x 113 x 120	6	188
300.073.405	400.073.405	113 x 210 x 73	12	168
300.073.405	400.073.405	117 x 210 x 73	6	276
300.120.415	400.120.415	113 x 210 x 120	3	379
300.085.425	400.085.425	130 x 245 x 85	2	000
300.140.425	400.140.425	130 x 245 x 140	2	487
300.100.505	400.100.505	210 x 280 x 100	1	758
300.135.605	400.135.605	210 x 280 x 135	1	895
300.115.505	400.115.505	260 x 350 x 115	1	1182
300.155.605	400.155.605	260 x 350 x 155	1	1287
300.150.705	400.150.705	265 x 355 x 153	1	1260
300.185.705	400.185.705	265 x 355 x 186	1	1365



DAHİLİ PRİZ KUTULARI

Surface Socket Boxes

- Dahili priz kutuları ofislerde ve çalışma alanlarında, çoklu konnektör çıkışı gereken yerlerde kullanılır. Duvarda bulunan kablo kanallarına teğet monte edilir.

Surface Socket Boxes are mostly used in offices and working areas, where multiple connectors needed. The boxes tangentially mounted to the wiring trunkings.

- 45mm soket sistemine uyumlu yapısı ile farklı standartlarda priz kullanımı, Data, Telefon ve Multimedya konnektörleri için uygun bir çözümdür.

The 45mm compatible structure, Surface Socket Boxes are responsive to our modular system with alternatives standard sockets, telephone, data, and multimedia solutions.

210 Dahili Priz Kutuları / 210 Surface Socket Boxes

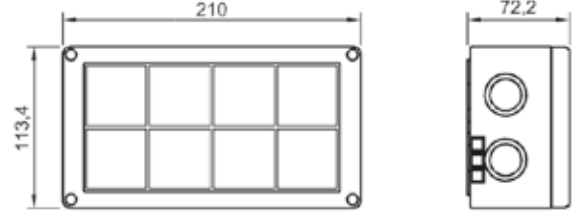

210.0000.0000

113 x 210 x 70 mm

210 ile bazı örnekler some examples with 210



210.1200.4400

4 Şebeke Prizi / Schuko Socket
4 UPS Prizi / Unischuko Socket



210.15.51.10.42112

4 Şebeke Prizi / Schuko Socket
2 Fransız Prizi / French Socket
1 VGA - 1 Sterio - 2 USB



210.10.7836.42222

4 Şebeke Prizi / Schuko Socket
2 CAT3 - 2 CAT6 - 2 HDMI
2 RCA



211.2000.0600

2 Sigorta / MCB
6 Fransız Prizi / French Socket



211.1000.6000

2 Sigorta / MCB
6 Şebeke Prizi / Schuko Socket



210.1278.2222

2 Sigorta / MCB - 2 CAT3 - 2 CAT6
2 Şebeke Prizi / Schuko Socket
2 UPS Prizi / Unischuko Socket

280 Dahili Priz Kutuları / 280 Surface Socket Boxes



210.0000.0000

210 x 280 x 70 mm

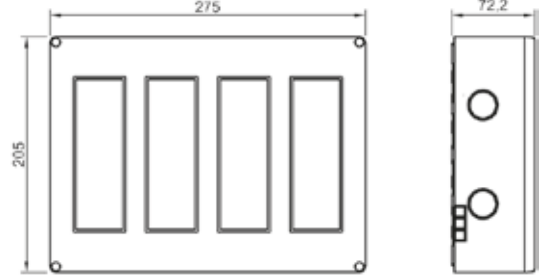

280 ile bazı örnekler
some examples with 280



280.1200.6600

6 Şebeke Prizi / Schuko Socket
6 UPS Prizi / Unischuko Socket



281.1200.6300

2 Sigorta / MCB
6 Şebeke Prizi / Schuko Socket
3 Fransız Prizi / French Socket



280.15.678.333333

3 Şebeke Prizi / Schuko Socket
3 Fransız Prizi / French Socket
3 CAT3 - 3 CAT6 - 3 Sterio - 3 RCA



282.15.80.33330

2 Sigorta / MCB - 3 DATA
3 Şebeke Prizi / Schuko Socket
3 Fransız Prizi / French Socket



282.146.3330

2 Sigorta / MCB - 3 İngiliz Prizi / BS Socket
3 Şebeke Prizi / Schuko Socket
3 Üniversal Prizi / Universal Socket



282.10.7859.33333

2 Sigorta / MCB
3 Şebeke Prizi / Schuko Socket
3 CAT3 - 3 CAT6 - 3 Stereo - 3 RCA

TEM®



DAĞITIM PANOLARI

Distribution Boards



Distribution Board — Power of the Box

- **Metal panolara göre hafif oluşu sebebiyle taşıma ve montaj kolaylığı.**
Ease of carrying and fitting due to his lightness comparing to metal enclosures.
- **Geniş ağız özelliği ile sağa veya sola 210° açılabilir kapak.**
With wide mouth cover can be opened 210° to left and right.
- **Kullanım sıcaklığı: -25 ... +60° C**
Temparature of use: -25 ... +60° C
- **Sac panolara göre daha kolay delinebilir ve delinince boyası bozulmaz, paslanma oluşmaz.**
Compared to Metal Enclosures it is easier to drill. Once drilled, paint is not damaged and corrosion does not occur.
- **Elektrik kaçağına karşı doğal izolasyonlu.**
Naturally insulated against electric leakage.
- **Halogen-Free**
- **IP65**

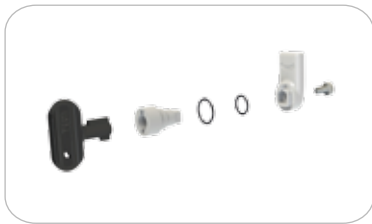

Plastik kilit sistemi
Plastic lock system

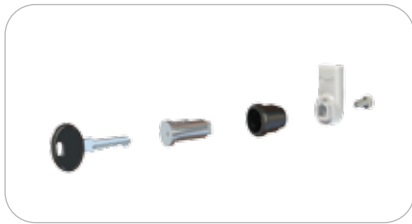

Metal kilit sistemi
Metal lock system



Melzeme / Materials:

- Mat Plastik Kapak / Plastic Opaque Cover: ABS RAL 7035 -Light Grey
- Şeffaf Plastik Kapak / Plastic Transparent Cover: Polycarbonate -Grey Transparent
- Plastik Alt Gövde / Plastic Case Body: ABS RAL 7035 -Light Grey
- Conta / Gasket: Polyurethane

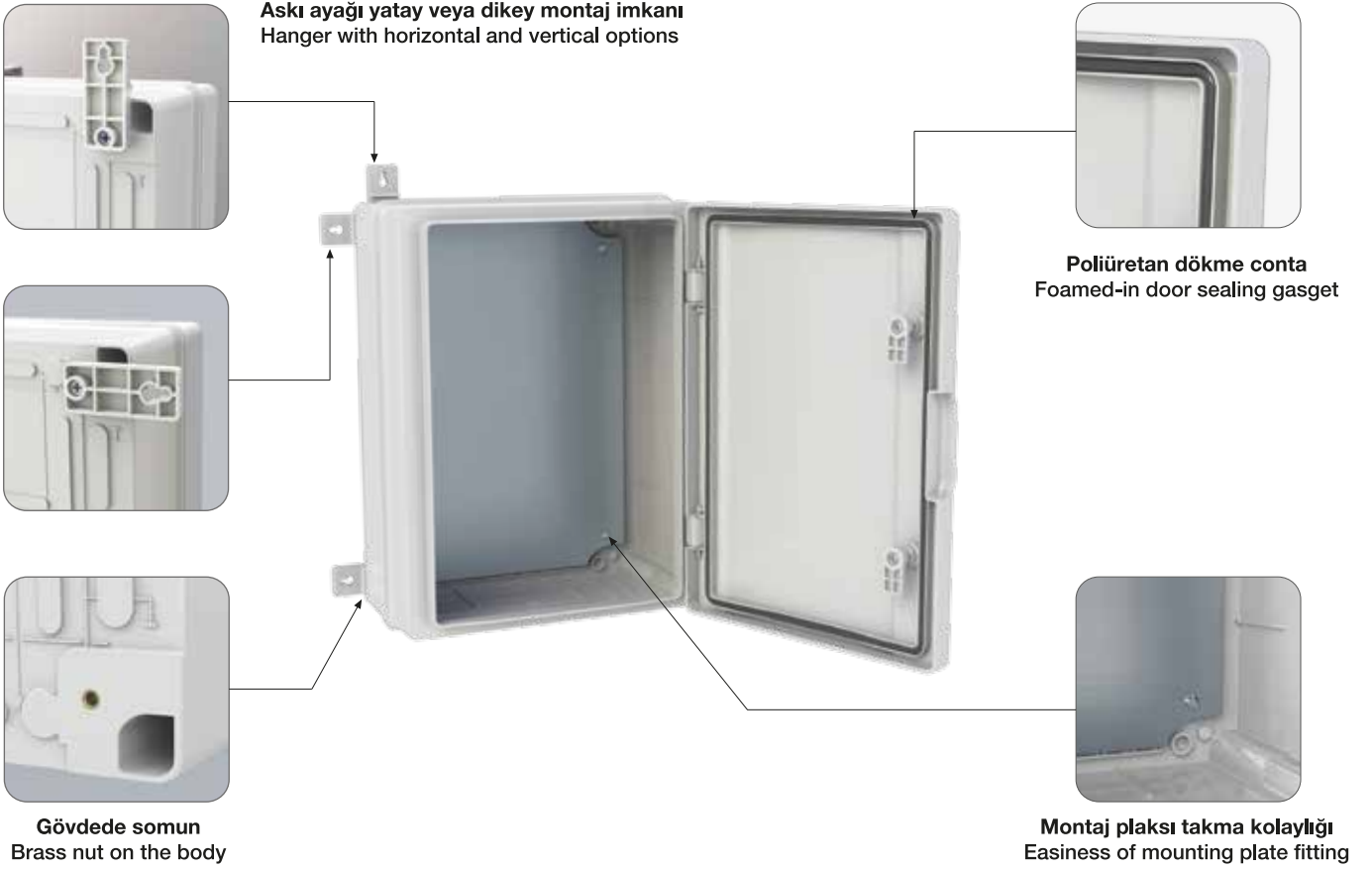

TEM Pano Boyutlar

Distribution Boards
Dimensions (cm)

21 x 30 x 13

26 x 35 x 15

26 x 35 x 18

30 x 40 x 13

30 x 40 x 17

30 x 40 x 19

30 x 40 x 23

40 x 50 x 20

40 x 60 x 20

50 x 70 x 25

Ref. Code

TEM Pano Çeşitleri / Distribution Boards Types

910

Taban saclı dağıtım panolar / Distribution board with metal mounting plate

920

Otomatik sigorta için perdeli dağıtım panolar / Distribution board with plate for MCB

922

Perdeli+Kompakt şalterli dağıtım panolar / Distribution board with plate for compact switch

923

Kofra dağıtım panolar / Distribution board with junction board

930-931

Monofaze sayaç için perdeli dağıtım panolar
Distribution board with plate for single phase energy meter

935

Trifaze sayaç için perdeli dağıtım panolar
Distribution board with plate for three phase energy meter

936

Trifaze sayaç ve otomatik sigorta için perdeli dağıtım panolar
Distribution board with plate for three phase energy meter and MCB

950

Boş pano / Empty distribution board

951

Harici telefon dağıtım panolar Çatılı / Distribution board with module mounting frame

952

Harici telefon dağıtım panolar Çatılı + Regletli
Distribution board with connection-disconnection module

960

Sulama ve asansör panolar / Distribution board with water pump and elevator

965-966

Şantiye panolar / Distribution board for construction site

Dağıtım Panoları / Distribution Boards

Dağıtım Panolarının Genel Ölçüleri General Dimensions of Distribution Boards



Ref. Code	Açıklama / Description
C1	Pano derinlik iç ölçüsü Internal dept dimation
C2	Pano alt kasa derinlik ölçüsü Nether base external dept dimation
C3	Pano çerçevenin dış ölçüsü Middle base external dept dimation
G - K - N	Kulaklarla dik bağlanacak ise Vertical mounting with hangers
F - J - N	Kulaklarla yatay bağlanacak ise Horizontal mounting with hangers
G - J - M	Gövde somunlarıyla bağlanacak ise Mounting with on body nuts
H - I - L	İçinden duvara bağlanacak ise Mounting from the inside to the wall

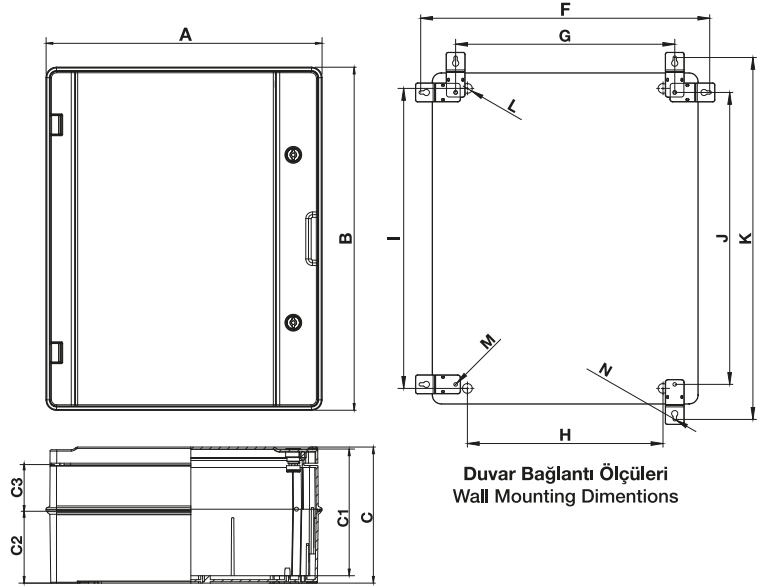

Boyutlar Dimensions cm	Dış External (mm)			Derinlik Depth (mm)			Duvar Montaj / Wall Mounting (mm)										
	A	B	C	C1	C2	C3	D	E	F	G	H	I	J	K	L	M	N
21x30x13	221	311	137	124.5	90	23	270	174.5	253.5	146	118	261	248.5	355.5	15	M5	2.5
26x35x15	265	355	152	138.5	78	51	315	227	305	198	198	318	291	398	15	M5	2.5
26x35x18	265	355	182	169	108	51	315	227	305	198	198	318	291	398	15	M5	2.5
30x40x13	310	410	132	118	80	28	360	245	343	236	200	360	347.5	456	15	M5	2.5
30x40x17	310	410	170	157	81	67	360	245	343	236	200	360	347.5	456	15	M5	2.5
30x40x19	310	410	190	177	141	28	360	245	343	236	200	360	347.5	456	15	M5	2.5
30x40x23	310	410	230	217	140	67	360	245	343	236	200	360	347.5	456	15	M5	2.5
40x50x20	410	510	202	188.5	107	71	470	345	442	336	300	460	447.5	555	15	M5	2.5
40x60x20	410	610	202	189	133	55	564	375	442	336	300	560	550	657	15	M5	2.5
50x70x25	511	711	253.5	239.5	182	47	660	472	547	440	400	660	650	757	15	M5	2.5

Taban Saclı Dağıtım Panoları Distribution Board with Metal Mounting Plate

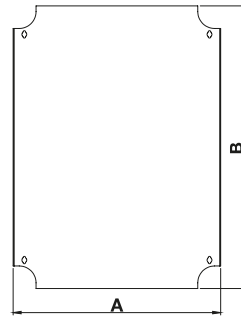

Pano İçi Taban Sacı
Metal Base Plate

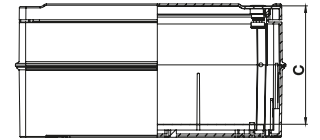
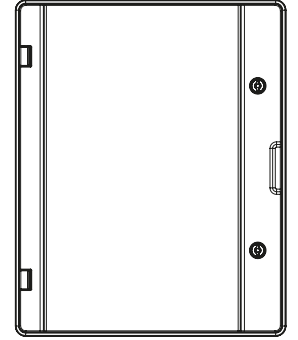

Ref. Code	Açıklama / Description
A - B	Pano İçi Taban Sacı dış ölçüler Metal Base Plate external dimensions
C	Pano sac üst - pano kapak alt arası mesafe distance between the cover and the metal plate

Boyutlar Dimensions cm	Ref. Code		Taban Sacı Ölçüleri Metal Plate Dimensions (mm)			📦	📊 gr.
	Opak Kapak Opaque Cover	Şeffaf Kapak Transparent Cover	A	B	C		
21x30x13	910.2130.131.000	910.2130.132.000	170	270	120	20	1382
26x35x15	910.2635.151.000	910.2635.152.000	227	315	130	12	1986
26x35x18	910.2635.181.000	910.2635.182.000	227	315	159	12	1821
30x40x13	910.3040.131.000	910.3040.132.000	257	360	111	10	2434
30x40x17	910.3040.171.000	910.3040.172.000	257	360	152	8	2647
30x40x19	910.3040.191.000	910.3040.192.000	257	360	176	8	2707
30x40x23	910.3040.231.000	910.3040.232.000	257	360	214	8	2907
40x50x20	910.4050.201.000	910.4050.202.000	345	470	180	6	4604
40x60x20	910.4060.201.000	910.4060.202.000	370	602	179	6	5151
50x70x25	910.5070.251.000	910.5070.252.000	473	672	230	4	9774

Otomatik Sigorta için Perdeli Dağıtım Panoları Distribution Board with Plate for MCB

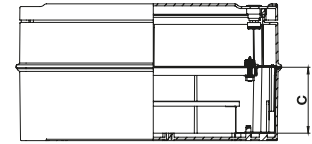
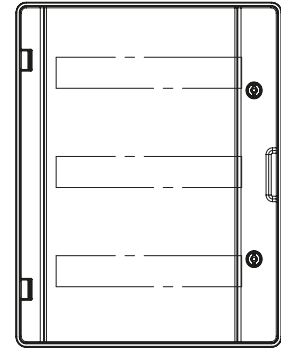

Ref. Code	Açıklama / Description
C	Izgara üst - pano sac alt arası mesafe distance between the mounting grills and the cover plate

Boyutlar Dimensions cm	Ref. Code		Açıklama Description	Perde Ölçüsü Dimension (mm) C	gr.	gr.
	Opak Kapak Opaque Cover	Şeffaf Kapak Transparent Cover				
21x30x13	920.2130.131.016	920.2130.132.016	2x8 Sigorta / MCB	52	20	1715
26x35x15	920.2635.151.018	920.2635.152.018	2x9 Sigorta / MCB	53	12	2418
30x40x13	920.3040.131.024	920.3040.132.024	3x8 Sigorta / MCB	75	10	3451
30x40x17	920.3040.171.024	920.3040.172.024	3x8 Sigorta / MCB	75	8	2664
40x50x20	920.4050.201.048	920.4050.202.048	3x16 Sigorta / MCB	90	6	5885
40x60x20	920.4060.201.064	920.4060.202.064	4x16 Sigorta / MCB	90	6	6791
50x70x25	920.5070.251.100	920.5070.252.100	5x20 Sigorta / MCB	98	4	11239

Kompakt Şalterli Perdeli Dağıtım Panoları Distribution Board with Plate for Compact Switch

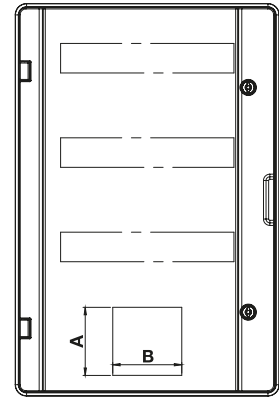

Ref. Code	Açıklama / Description
A - B	Şalter deliği yüksekliği - genişliği ölçüsü Dimension(high - width) of hole of Switch
C	İzgara üst - pano sac alt arası mesafe distance between the mounting grills and the cover plate

Boyutlar Dimensions cm	Ref. Code		Açıklama Description	Perde Ölçüsü Dimension (mm)			📦	📦 gr.
	Opak Kapak Opaque Cover	Şeffaf Kapak Transparent Cover		A	B	C		
40x50x20	922.4050.201.032	922.4050.202.032	2x16 Sigorta / MCB + 1 Kompakt Şalter / MCCB	105	105	90	6	5941
40x60x20	922.4060.201.048	922.4060.202.048	3x16 Sigorta / MCB + 1 Kompakt Şalter / MCCB	105	105	90	6	6789
50x70x25	922.5070.251.080	922.5070.252.080	4x20 Sigorta / MCB + 1 Kompakt Şalter / MCCB	105	105	98	4	11243

Korfa Panoları Conduit Panels

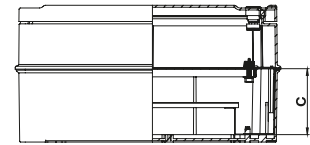
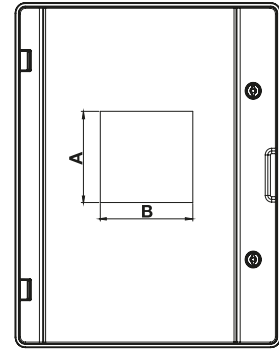

Ref. Code	Açıklama / Description
A - B	Şalter deliği yüksekliği - genişliği ölçüsü Dimension (height - width) of hole for Switch
C	İzgara üst - pano sac alt arası mesafe distance between the mounting grills and the cover plate

Boyutlar Dimensions cm	Ref. Code		Açıklama Description	Perde Ölçüsü Dimension (mm)			📦	📦 gr.
	Opak Kapak Opaque Cover	Şeffaf Kapak Transparent Cover		A	B	C		
26x35x15	923.2635.151.000	923.2635.152.000	1 Kompakt Şalter / MCCB	100	100	79	12	1517
30x40x17	923.3040.171.000	923.3040.172.000	1 Kompakt Şalter / MCCB	100	100	90	8	2070
40x50x20	923.4050.201.000	923.4050.202.000	1 Kompakt Şalter / MCCB	100	100	80	6	3588

Monofaze Sayaç için Perdeli Dağıtım Panoları Distribution Board with Plate for Single Phase Energy Meter

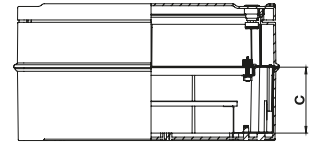
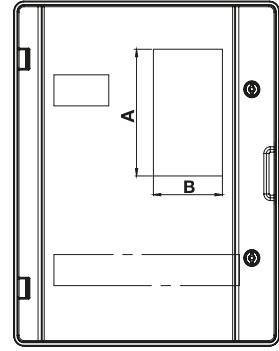

Ref. Code	Açıklama / Description
A - B	Sayaç deliği yüksekliği - genişliği ölçüsü Dimension (high - width) of hole for Energy Meter
C	İzgara üst - pano sac alt arası mesafe distance between the mounting grills and the cover plate

Boyutlar Dimensions cm	Ref. Code		Açıklama Description	Perde Ölçüsü Dimension (mm)			📦	📦 gr.
	Opak Kapak Opaque Cover	Şeffaf Kapak Transparent Cover		A	B	C		
21x30x13	930.2130.131.003	930.2130.132.003	3 Sigorta / MCB + 1 Sayaç / Energy Meter	92	92	52	20	2422
26x35x15	930.2635.151.003	930.2635.152.003	3 Sigorta / MCB + 1 Sayaç / Energy Meter	100	92	53	12	2450
30x40x13	931.3040.131.013	931.3040.132.013	13 Sigorta / MCB + 1 Sayaç / Energy Meter	135	85	75	10	3384
30x40x17	931.3040.171.013	931.3040.172.013	13 Sigorta / MCB + 1 Sayaç / Energy Meter	135	85	75	8	3597
40x50x20	931.4050.201.224	931.4050.202.224	24 Sigorta / MCB + 2 Sayaç / Energy Meter	95	95	90	6	6718

Trifaze Sayaç için Perdeli Panoları

Distribution Board with Plate for Three Phase Energy Meter

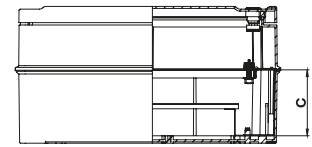
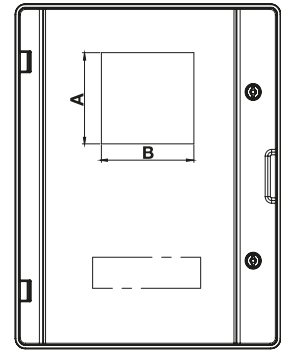

Ref. Code	Açıklama / Description
A - B	Sayaç deliği yüksekliği - genişliği ölçüsü Dimension(high - width) of hole of Energy Meter
C	İzgara üst - pano sac alt arası mesafe distance between the mounting grills and the cover plate

Boyutlar Dimensions cm	Ref. Code		Açıklama Description	Perde Ölçüsü Dimension (mm)			📦	📦 gr.
	Opak Kapak Opaque Cover	Şeffaf Kapak Transparent Cover		A	B	C		
30x40x13	935.3040.131.010	935.3040.132.010	10 Sigorta / MCB + 1 Sayaç / Energy Meter	180	155	75	10	3065
30x40x17	935.3040.171.010	935.3040.172.010	10 Sigorta / MCB + 1 Sayaç / Energy Meter	180	155	75	8	3278
40x50x20	935.4050.201.008	935.4050.202.008	8 Sigorta / MCB + 1 Sayaç / Energy Meter	125	125	90	6	6101
40x60x20	935.4060.201.008	935.4060.202.008	8 Sigorta / MCB + 1 Sayaç / Energy Meter	125	125	90	6	6850
50x70x25	935.5070.251.010	935.5070.252.010	10 Sigorta / MCB + 1 Sayaç / Energy Meter	125	125	98	4	11174

Trifaze Sayaç ve Otomatik Sigorta için Perdeli Dağıtım Panoları Distribution Board with Plate for Three Phase Energy Meter and MCB

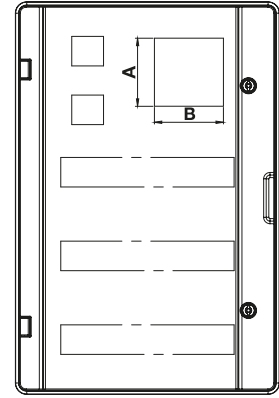

Ref. Code	Açıklama / Description
A- B	Sayaç deliği yüksekliği - genişliği ölçüsü Dimension (high - width) of hole of Energy Meter
C	İzgara üst - pano sac alt arası mesafe distance between the mounting grills and the cover plate

Boyutlar Dimensions cm	Ref. Code		Açıklama Description	Perde Ölçüsü Dimension (mm)			gr.	gr.
	Opak Kapak Opaque Cover	Şeffaf Kapak Transparent Cover		A	B	C		
40x50x20	936.4050.201.024	936.4050.202.024	24 Sigorta / MCB + 1 Sayaç / Energy Meter	125	125	90	6	6132
40x50x20	936.4050.201.112	936.4050.202.112	24 Sigorta / MCB + 1 Sayaç / Energy Meter + Kauçuk Prizler / Rubber Sockets	125	125	90	6	6496
40x60x20	936.4060.201.040	936.4060.202.040	40 Sigorta / MCB + 1 Sayaç / Energy Meter	125	125	90	6	7090
50x70x25	936.5070.251.068	936.5070.252.068	68 Sigorta / MCB + 1 Sayaç / Energy Meter	125	125	98	4	11693

Dağıtım Panoları / Distribution Boards

Harici Telefon Dağıtım Panoları Distribution Board for Telephone Modules

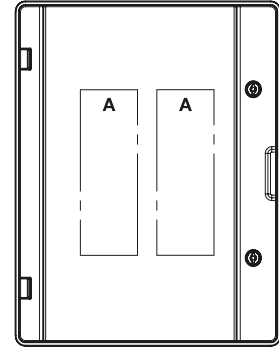

Ref. Code	Açıklama / Description
A	Reglet çatı sayısı Number of chassis for module
B	Toplam reglet kapasitesi Total capacity of module

Boyutlar Dimensions cm	Ref. Code		Açıklama Description	Ölçü (mm) Dimension		gr.	gr.		
	Opak Kapak Opaque Cover	Şeffaf Kapak Transparent Cover		A	B		150	151	152
21x30x13	XXX.2130.131.030	XXX.2130.132.030	Çatı / Chasis + Regletli 30 per / 30 Modules	1	3	20	1104	1164	1326
26x35x15	XXX.2635.151.050	XXX.2635.152.050	Çatı / Chasis + Regletli 50 per / 50 Modules	1	5	12	1517	1617	1887
30x40x13	XXX.3040.131.100	XXX.3040.132.100	Çatı / Chasis + Regletli 100 per / 100 Modules	1	10	10	1857	2020	2560
30x40x17	XXX.3040.171.100	XXX.3040.172.100	Çatı / Chasis + Regletli 100 per / 100 Modules	1	10	8	2070	2233	2773
40x50x20	XXX.4050.201.150	XXX.4050.202.150	Çatı / Chasis + Regletli 150 per / 150 Modules	1	30	6	3588	3987	4797
40x50x20	XXX.4050.201.200	XXX.4050.202.200	Çatı / Chasis + Regletli 200 per / 200 Modules	2	30	6	3588	3914	14714
40x50x20	XXX.4050.201.300	XXX.4050.202.300	Çatı / Chasis + Regletli 300 per / 300 Modules	2	30	6	3588	4386	6006
40x60x20	XXX.4060.201.400	XXX.4060.202.400	Çatı / Chasis + Regletli 400 per / 400 Modules	2	40	6	3802	4860	7020
50x70x25	XXX.5070.251.500	XXX.5070.251.500	Çatı / Chasis + Regletli 500 per / 500 Modules	2	50	4	7208	8514	11214

XXX=150 Boş pano / Empty distribution board

XXX=151 Harici telefon dağıtım panolar Çatılı / Distribution board with module mounting frame



XXX=152 Harici telefon dağıtım panolar Çatılı + Regletli / Distribution board with connection-disconnection module

Sulama Panoları

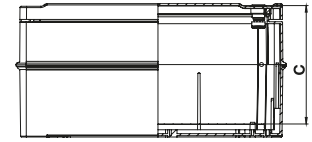
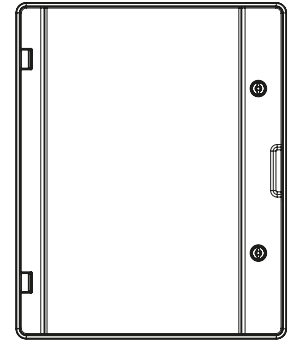
Distribution Board for Water Pump



Ref. Code	Açıklama / Description
C	İzgara üst - pano sac alt arası mesafe distance between the mounting grills and the cover plate

Boyutlar Dimensions cm	Ref. Code		Açıklama Description	Perde Ölçüsü Dimension (mm)		 gr.
	Opak Kapak Opaque Cover	Şeffaf Kapak Transparent Cover		C		
40x50x20	960.4050.201.000	960.4050.202.000	Sinyal / Signal + Voltmetre / Voltmeter + Ampermetre / Ampermeter	180	6	4974
40x60x20	960.4060.201.000	960.4060.202.000	Sinyal / Signal + Voltmetre / Voltmeter + Ampermetre / Ampermeter	179	6	5715
50x70x25	960.5070.251.000	960.5070.252.000	Sinyal / Signal + Voltmetre / Voltmeter + Ampermetre / Ampermeter	230	4	9392

Dağıtım Panoları / Distribution Boards

Asansör Panoları Elevator Panels

Boyutlar Dimensions cm	Ref. Code	Açıklama Description		 gr.
26x35x15	960.2635.151.000	1 5X40A Pako 1 2X25A 300 mA KAKR 1 4X40A 300 mA KAKR 3 Ø=22 Sinyal / Signal + 3 C1X16A Sigorta / MCB +	1	0000
30x40x13	960.3040.131.000	1 C4X40A Sigorta / MCB + 3 1X16A Şebeke Priz / Schuko Socket	1	2667



Şantiye Özel Panolar Distribution Board for Construction Site



936.4050.201.112



965.4060.201.016

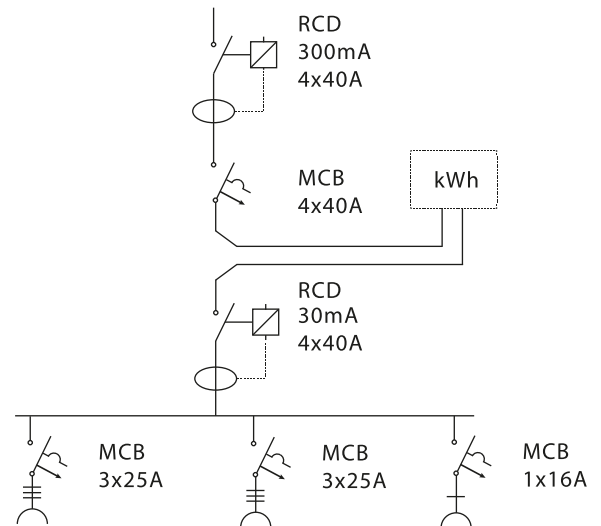
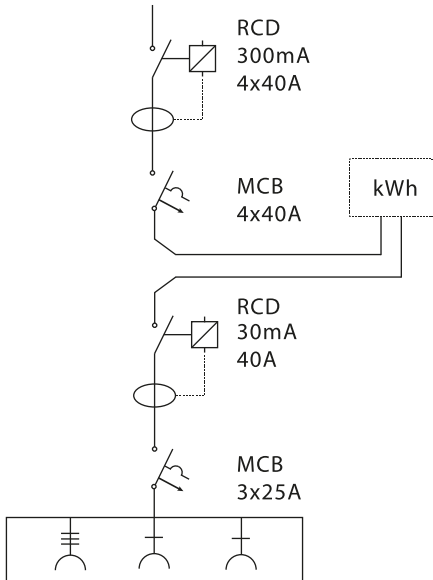

Şantiye Panoları

Distribution Board for Construction Site

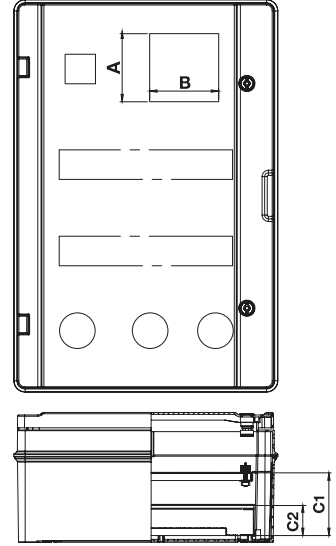

Ref. Code	Açıklama / Description
A - B	Sayaç deliği yüksekliği - genişliği ölçüsü Dimension(high - width) of hole of Energy Meter
C1	Sigorta izgara üst - pano sac alt arası mesafe distance between the MCB mounting grills and the cover plate
C2	Priz izgara üst - pano sac alt arası mesafe distance between the sockets mounting grills and the cover plate

Boyutlar Dimensions cm	Ref. Code		Açıklama Description	Perde Ölçüsü Dimension (mm)				📦	📦 gr.
	Opak Kapak Opaque Cover	Şeffaf Kapak Transparent Cover		A	B	C1	C2		
40x60x20	965.4060.201.024	965.4060.202.024	24 Sigorta / MCB + 1 Trifaze Sayaç / Three Phase Energy Meter	125	125	90	82	6	6881
50x70x25	965.5070.251.048	965.5070.252.048	48 Sigorta / MCB + 1 Trifaze Sayaç / Three Phase Energy Meter	125	125	98	41	4	11445
50x70x25	965.5070.251.028	965.5070.252.028	28 Sigorta / MCB + 1 Trifaze Sayaç / Three Phase Energy Meter	125	125	98	41	4	9775
40x50x20	966.4050.201.032	966.4050.202.032	32 Sigorta / MCB	-	-	90	85	6	5683
40x60x20	966.4060.201.048	966.4060.202.048	48 Sigorta / MCB	-	-	90	82	6	6586
40x60x20	966.4060.201.032	966.4060.202.032	32 Sigorta / MCB	-	-	90	82	6	6392
50x70x25	966.5070.251.060	966.5070.252.060	60 Sigorta / MCB	-	-	98	41	4	10849

Panolar Aksesuarları Distribution Board Accessories



740.030.045



740.020.000



Ref. Code	Açıklama Description	Kullanılabilen Ürünler Available Products		 gr.
740.020.000	Pano Ayak Mounting Stand	40x50 - 40x60 - 50x70	1	790
740.030.026	Çatı / Roof	26x35	1	450
740.030.030	Çatı / Roof	30x40	1	605
740.030.045	Çatı / Roof	40x50 - 40x60	1	1057
740.030.050	Çatı / Roof	50x70	1	1530





740.011.000



740.010.001



Ref. Code	Açıklama / Description		 gr.
740.010.001	Reglet-Kemesli / Module with Section	100	54
740.020.002	Reglet-Kesmesiz / Module without Section	100	54
740.011.026	Çatı-Tekli / Roofing - Singel	100	22

Panolar Aksesuarları Distribution Board Accessories



30x60 TAŞIYICI AYAK / POD-FEET

Ref Code: 740.022.001

310 x 610 x 330 mm
12.2 x 24.4 x 13 inch

Taşıyıcıya monte edilebilir ürünler / for the products below:

- 21x28 - 26x35 Kombinasyon Kutular / Combination Boxes
- 21x28 - 26x35 Termoplastik Buatlar / Thermoplastic Enclosures
- 26x35 - 30x40 Dağıtım Panolar / Distribution Boards



50x100 TAŞIYICI AYAK / POD-FEET

Ref Code: 740.022.002

510 x 1010 x 600 mm
20 x 39.7 x 23.6 inch

Taşıyıcıya monte edilebilir ürünler / for the products below:

- 40x50 - 40x60 - 50x70 Dağıtım Panolar / Distribution Boards

30x40 Pano / Distribution Board
931.3040.172.013
740.022.001



40x50 Pano / Distribution Board
966.4050.201.032
740.022.002



40x60 Pano / Distribution Board
966.4060.201.048
740.022.002



TEM®



KABLO MAKARALARI

Cable Reels

Plastik Gövdeli Makara / Plastic Cable Reels





M150 Monofaze Prizli Makara
M 150 Cable Reel with Singel Phase Sockets

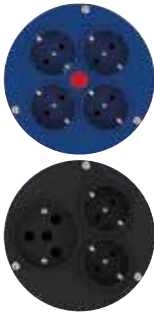

M160 Trifaze Prizli Makara
M160 Cable Reel with Three Phase Sockets





Ref. Code	Sockets	Kablo Kapasitesi Cable Capacity		 gr.
150.000.04	4(1x16A) schuko	50 m	1	3370
160.425.12	1(4x25A) + 2(1x16A)	50 m	1	3380

Kablo Kesintine Göre Makaraların kapasitesi (m) Cable Reels Capacity Base on Cable intervals (m)

Kablo Kapasitesi Cable Capacity	3x1.5 TTR	3x2.5 TTR	3x4 TTR	4x1.5 TTR	4x2.5 TTR	4x4 TTR
150.000.04	60	50	40	-	-	-
160.425.12	60	50	40	50	35	25

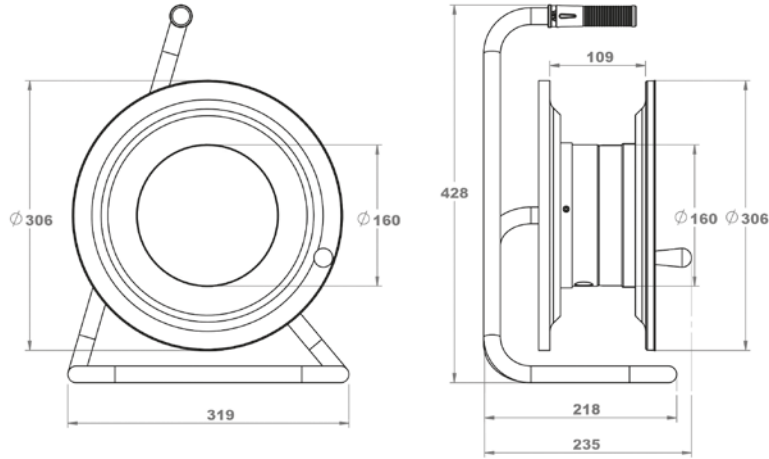
M100 Makara Grubu / M100 Cable Reels Group



Ref. Code	Sockets	Kablo Kapasitesi Cable Capacity		 gr.
100.000.004	4(1x16A) schuko	50 m	1	3370
100.000.004.T	4(1x16A) schuko + thermal switch	50 m	1	3380

M120 Makara Grubu / M120 Cable Reels Group

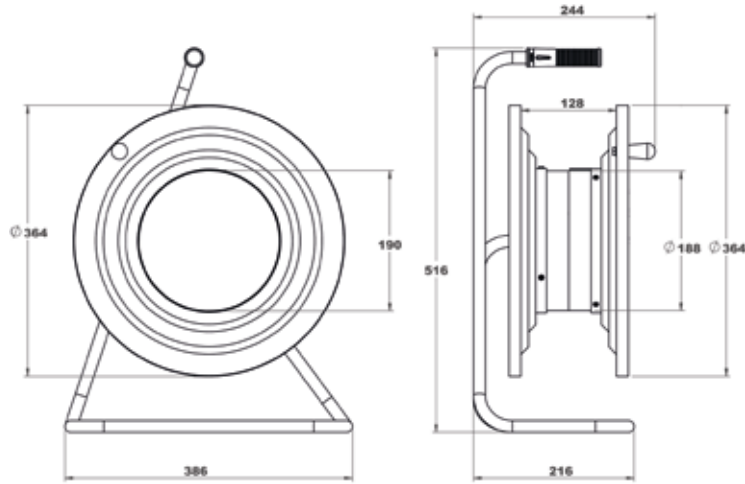

					
Ref. Code	12X.000.004.T	12X.316.012	12X.516.012	12X.432.012	12X.532.012
Sockets	4(1x16A) schuko + thermal switch	1(3x16A) CEE 2(1x16A) schuko	1(5x16A) CEE 2(1x16A) schuko	1(4x32A) CEE 2(1x16A) schuko	1(5x32A) CEE 2(1x16A) schuko
Kablo Kapasitesi Cable Capacity	100 m	50 m	50 m	50 m	50 m
	1	1	1	1	1
 gr.	3275	3370	3370	3370	3370

- X=0 - Borulu tip makara / Tubular cable reel
- X=1 - Arabalı tip makara / Cable reel with car

- X=2 - Tekerlikli tip makara / wheeled cable reel

M130 Makara Grubu / M130 Cable Reels Group

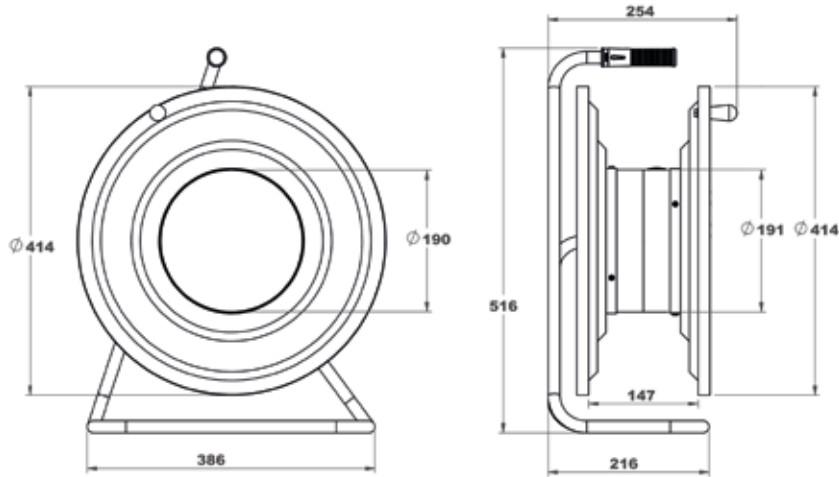

					
Ref. Code	13X.000.005.T	13X.516.021	13X.425.021	13X.432.012	13X.532.012
Sockets	5(1x16A) schuko	2(5x16A) CEE 1(1x16A) schuko	2(4x25A) 1(1x16A) schuko	1(4x32A) CEE 2(1x16A) schuko	1(5x32A) CEE 2(1x16A) schuko
Kablo Kapasitesi Cable Capacity	100 m	100 m	100 m	100 m	100 m
	1	1	1	1	1
 gr.	3370	3910	3910	3883	3370

- X=0 - Borulu tip makara / Tubular cable reel
- X=1 - Arabalı tip makara / Cable reel with car

- X=2 - Tekerlikli tip makara / wheeled cable reel

M140 Makara Grubu / M140 Cable Reels Group

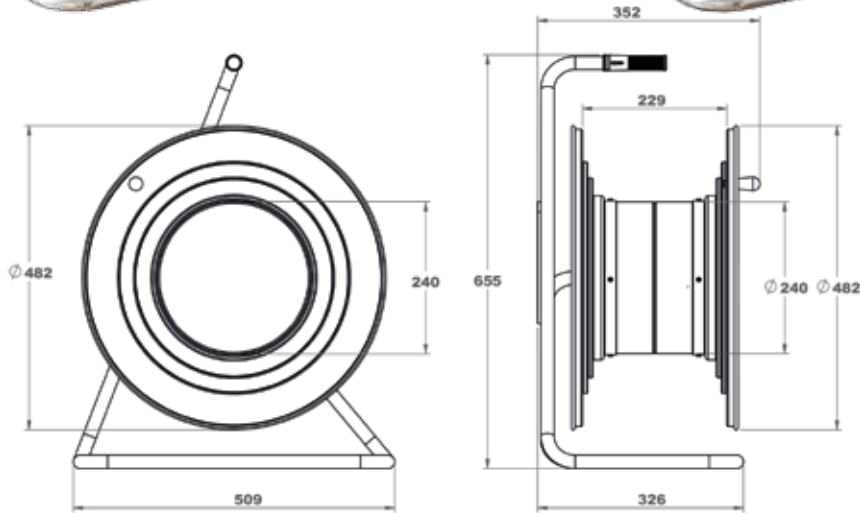

					
Ref. Code	14X.416.022.T	14X.516.022.2T	14X.425.022	14X.432.022	14X.532.022
Sockets	2(4x16A) CEE 2(1x16A) schuko + thermal switch	2(5x16A) CEE 2(1x16A) schuko +2thermal switch	2(4x25A) CEE 2(1x16A) schuko	2(4x32A) CEE 2(1x16A) schuko	1(5x32A) CEE 2(1x16A) schuko
Kablo Kapasitesi Cable Capacity	100 m	100 m	100 m	100 m	50 m
	1	1	1	1	1
 gr.	3370	3370	3370	3370	3370

● X=0 - Borulu tip makara / Tubular cable reel
X=1 - Arabalı tip makara / Cable reel with car

X=2 - Tekerlikli tip makara / wheeled cable reel

Tekerlikli Makaraları / Wheeled Cable Reels



M120 Tekerlikli Makara
M 120 Wheeled Cable Reel



M130 Tekerlikli Makara
M 130 Wheeled Cable Reel



M140 Tekerlikli Makara
M 140 Wheeled Cable Reel

Arabalı Makaralar / Cable Reels with Car



M120 Arabalı Makara
M 120 Cable Reel with Car

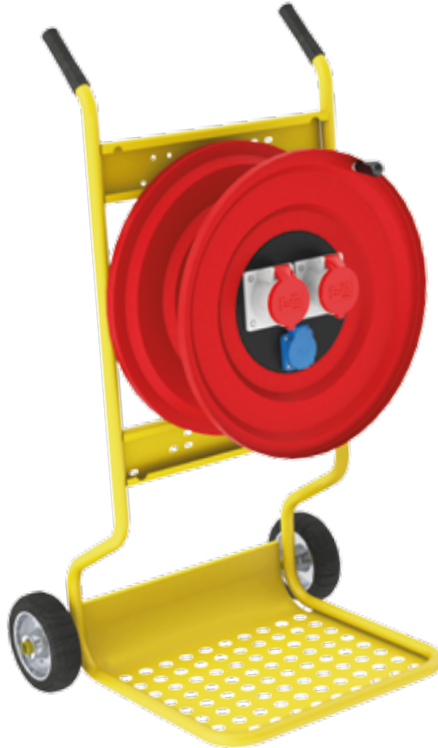

M130 Arabalı Makara
M 130 Cable Reel with Car



M140 Arabalı Makara
M 140 Cable Reel with Car

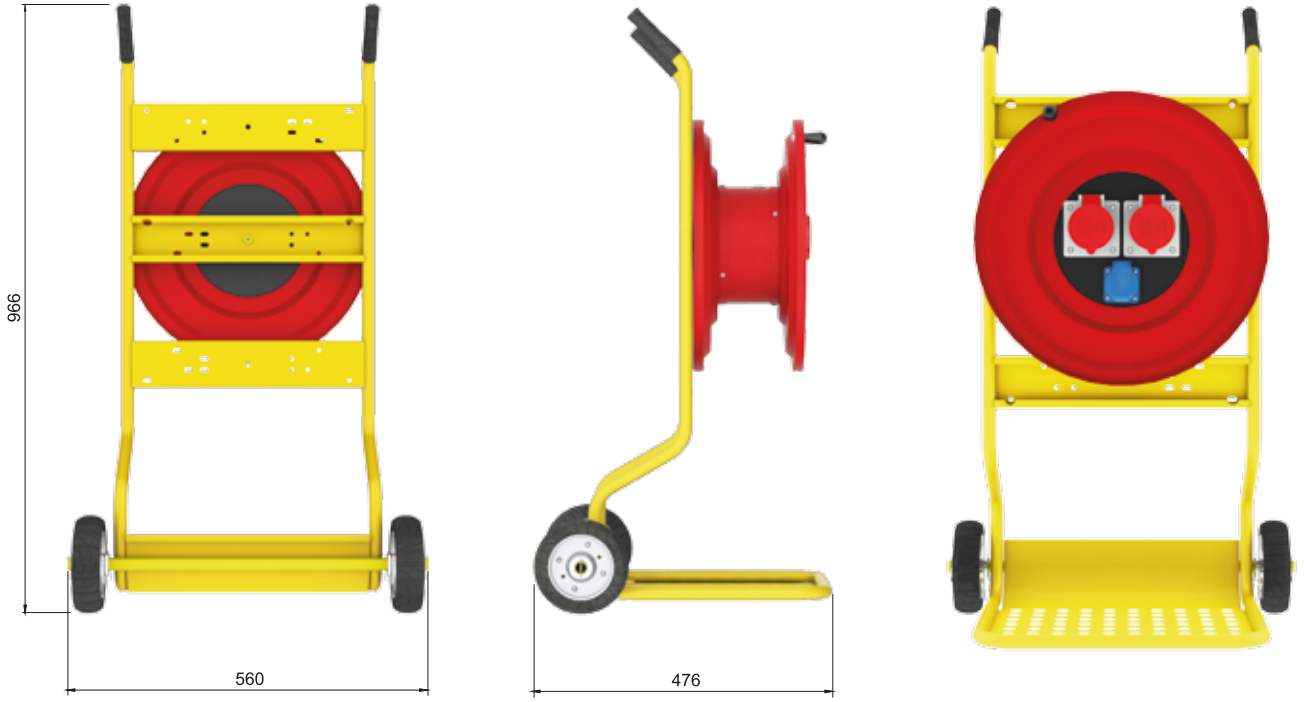

- Pano ve ya Kombinasyon kutuleri, arabanın arkasında monte etmek mümkündür.
It is possible to mount differet type of Distribution Boards or Combination boxes on the back side of the cart.



Arabalı Kombinasyonlu Makaraları
Cable Reels with Car & Combination Box



Arabalı Panolu Makaraları
Cable Reels with Car & Distribution Board

Kablo Makaraları / Cable Reels

Kablo Kesintine Göre Makaraların kapasitesi (m)
Cable Reels Capacity Base on Cable intervals (m)



M120 Makara
M120 Cable Reel



M130 Makara
M130 Cable Reel



M140 Makara
M140 Cable Reel

				
Kablo Kapasitesi Cable Capacity	100.XXX	120.XXX	130.XXX	140.XXX
3x1.5 TTR	50	100	120	180
3x2.5 TTR	40	75	100	140
3x4 TTR	30	60	75	125
4x1.5 TTR	-	80	100	170
4x2.5 TTR	-	65	80	130
4x4 TTR	-	45	55	100
5x1.5 TTR	-	75	100	135
5x2.5 TTR	-	50	70	110
5x4 TTR	-	40	50	90

TEM®

Alüminyum Grup Prizler PDU Group Products





Flip Power Frame



Power Frame



Cable Grommet

- TEM Güç Çerçevesi masanıza ya da mutfak dolabınıza monte edilebilir.
TEM Power Frame can be installed in your desks, or kitchen cupboards.



- Güç Çerçevesi Modüler 45mm prizler ve kapaklar için tasarlanmıştır.
Power Frame allows to use the modular 45mm mosaic sockets or faceplates.
- Modüler prizleri ve konnektörleri, masanın altına ya da üzerine monte etmek mümkündür.
Bu yönüyle masa üstünde ve altında tüm cihazların konnektör ihtiyaçlarını karşılar.
It is possible to mount the modular connectors on the top or bottom of the desk. This helps us to take power or take connections for the devices under the desk.

Güç Çerçevesi / Power Frame

- Güç Çerçevesi, mobilyanın yüzeyine yapılan kesime kolayca monte olur.
Power Frame easily adapts to your surface cut-out and blends effortlessly.
- Duvarınızda, ofis mobilyalarınızda veya masanızda yer kazanmanın kolay yoludur.
It is an easy way to save space on the desk, in office furniture or on the wall.
- İnce tasarımı sayesinde sığ alanlara monte edilebilir.
Its minimal height allows it to fit in even shallow surfaces.



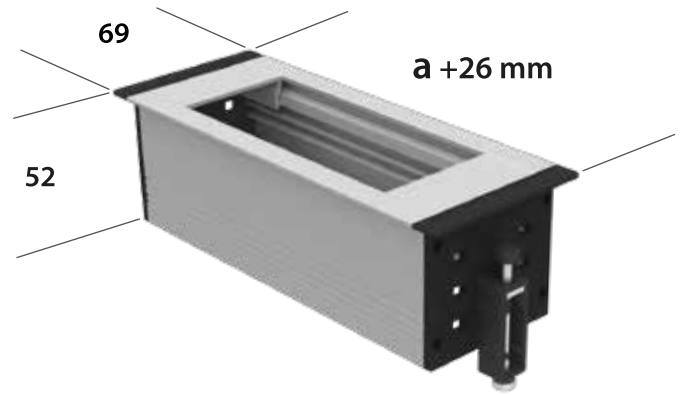
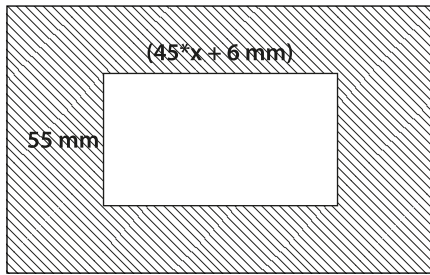

- **a** miktarı: Kanalın uzunluğudur.
a amount is the length of aluminium profile.

Ref. Code	Boş Güç Çerçevesi Empty Power Frame	a mm	Kesim Ölçüsü mm Cutting Dimension	
1720.0000.0010.0	5x45(2x22.5 Cover)	225	231x55	1
1720.0000.0012.0	6x45(2x22.5 Cover)	270	276x55	1
1720.0000.0014.0	7x45(2x22.5 Cover)	315	321x55	1
1720.0000.0016.0	8x45(2x22.5 Cover)	360	366x55	1

	Ref. Code	Güç Çerçevesi Power Frame	a mm	Kesim Ölçüsü mm Cutting Dimension	
	1720.1010.2010.0	2 Schuko + 1 USB	202,5	208,5x55	1
	1720.2087.3011.0	3 UPS + 1 Cat3 + 1 Cat6	270	276x55	1
	1720.4015.2011.0	2 British Socket + 1 VGA + 1 USB	259,5	265,5x55	1



TEM Cable Grommet

We produce solutions

- Mobilyada yapılan kesime kolay ve hızlıca monte edilir.
- Masa kapağı kablolarınızın ihtiyaç duyulan yere ulaşmasına aracı olur.
- Kapakta yer alan fırça, kapalıyken kablo geçişini sağlar.

Quickly and easily instered into the desk cut-out.

Cable Grommet guides the cables where they are needed.

Black Brush on the product allows to access the cables when the cover is closed.

- Masa Kapağı Ofis masaları ve konferans odaları kullanımına çok uygundur.
- TEM Güç Çerçevesi ile uyumludur.

Cable grommet especially well suited to desks in offices and conference rooms.

It can be combined with TEM Power Frame

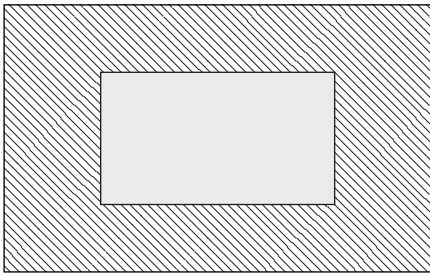

(45*x + 5 mm)

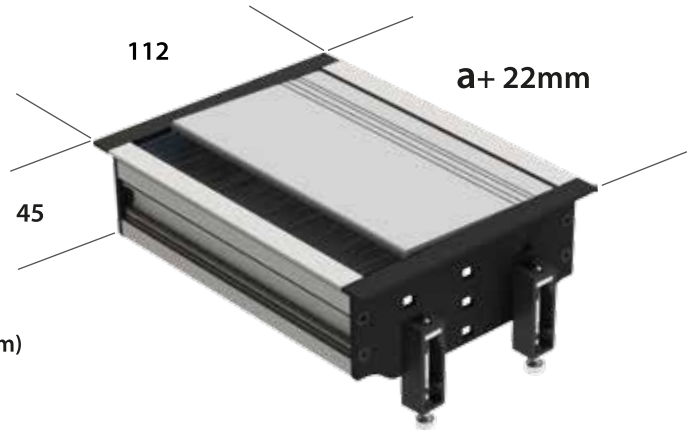

- **a** miktarı: Kanalın uzunluğudur.
a amount is the length of aluminum profile.

Ref. Code	Boş Masa Kapağı Empty Cable Grommet	a mm	Kesim Ölçüsü mm Cutting Dimension	
1710.0000.0010.0	5x45	225	230x105	1
1710.0000.0012.0	6x45	270	275x105	1
1710.0000.0014.0	7x45	315	320x105	1
1710.0000.0016.0	8x45	360	365x105	1

?



TEM Flip Power Frame — United Power solution

- **Kapaklı Güç Çerçevesi;** TEM Masa Kapağı ve TEM Güç Çerçevesi ürünlerinin birleşmesi ile oluşur.
- Her iki ürününün de avantajlarını taşır.

Flip Power Frame is a combination of TEM Cable Grommet & TEM Power Frame.

It has the advantages of two different products as one product.

- **Kapağındaki fırça sayesinde kullanırken kapağı kapatabilirsiniz.**

Black Brush on the product allows to access the cables when the cover is closed.



Mobilyada yapılan kesime kolay ve hızlıca monte edilir.
Quickly and easily instered into the desk cut-out.



Masa üstü ya da altında bağlantıları kolaylaştırır.
It allows to make connctions up or under the desk.

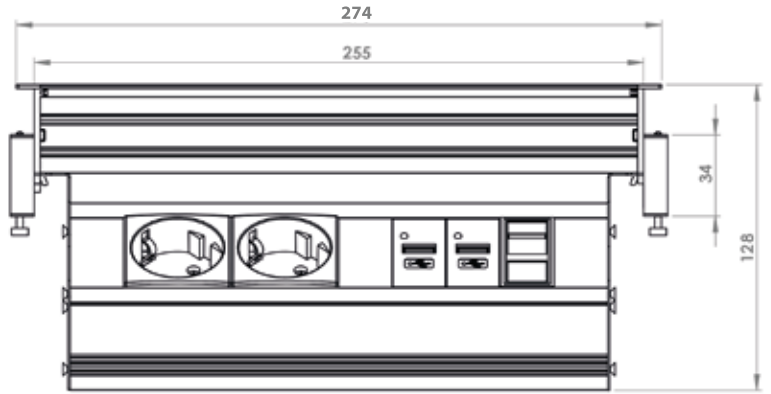
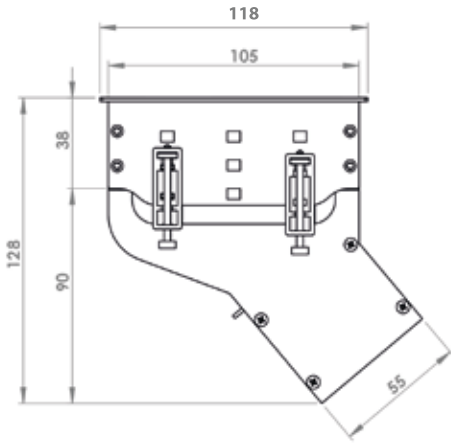

- **Özellikle çalışma alanı masaları ve konferans odaları için kullanışlıdır.**

Flip Power Frame especially well suited to work stations and conference rooms.

- **Güç erişimi gerektiren her çeşit masada uygun çözümler sağlar.**

It is a solution for all type of desks that needs to access distribution of power.

- **Modüler 45mm prizler ve kapaklar ile uyumludur.**

Allows to use the modular 45mm mosaic sockets or faceplates.

- **Karşılaştırılabilir ürün: Yatay Masa Prizi (sayfa: 80)**

Compatible Product Horizontal Desk Socket (page: 80)

Kapaklı Güç Çerçevesi / Flip Power Frame

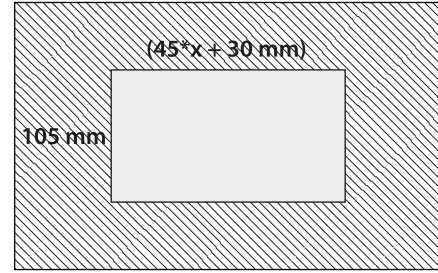

- **a** miktarı: Kanalın uzunluğudur.
a amount is the length of aluminium profile.

Ref. Code	Boş Kapaklı Güç Çerçevesi Empty Flip Power Frame	a mm	Kesim Ölçüsü mm Cutting Dimension	
1730.0000.0010.0	5x45(2x22.5 Cover)	225	255x105	1
1730.0000.0012.0	6x45(2x22.5 Cover)	270	300x105	1
1730.0000.0014.0	7x45(2x22.5 Cover)	315	345x105	1
1730.0000.0016.0	8x45(2x22.5 Cover)	360	390x105	1



Ref. Code	Kapaklı Güç Çerçevesi Flip Power Frame	a mm	Kesim Ölçüsü mm Cutting Dimension	
1730.1010.2010.0	2 Schuko + 1 USB	180	210x105	1

1730.1010.2020.0	2 Schuko + 2 USB	202,5	332x105	1
------------------	------------------	-------	---------	---

1730.1287.2211.0	2 Schuko + 2 UPS + 1 Cat6 + 1 Cat3	315	345x105	1
------------------	---------------------------------------	-----	---------	---

1730.1620.3110.0	3 Schuko + 1 Universal + 2 USB	315	345x105	1
------------------	-----------------------------------	-----	---------	---



Horizontal Desk Socket — Yatay Masa Prizi

- Yatay Masa Prizi size yüksek işlevsellik sunar.
- Güç, data ve multimedya konnektörlerinin tümünü masanıza taşır.
- Modüler 45mm prizler ve kapaklar ile uyumludur. The Horizontal Desk Socket offers you high functionality.

Complete unit for power, data and media connections on desks and conference tables.

Allows to use the modular 45mm mosaic sockets or faceplates.

Yatay Masa Prizi / Horizontal Desk Socket



- İlk bağlantıda kablo klemensine kolay erişim sağlayan kapağı vardır.
It has easy access covers for the first connection trough the cable terminal.
- Masa altı kablo giriş deliği sayesinde, onarım ve yenileme durumunda esneklik sağlar.
Under desk cable entrance hole, allows flexibility in case of any renovation.
- Mobilyada yapılan kesime, plastik kapakları sayesinde kolay ve hızlıca monte edilir.
Quickly and easily inserted into the desk cut-out and fixed into desk with plastic side covers.

Yatay Masa Prizi / Horizontal Desk Socket

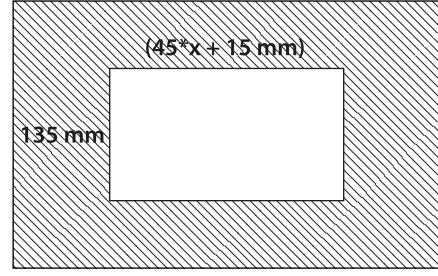

Ref. Code	Boş Yatay Masa Prizi Empty Horizontal Desk Socket	a mm	Kesim Ölçüsü mm Cutting Dimension	
1740.0000.0010.0	5x45(2x22.5 Cover)	225	240x135	12
1740.0000.0012.0	6x45(2x22.5 Cover)	270	285x135	12
1740.0000.0014.0	7x45(2x22.5 Cover)	315	330x135	12
1740.0000.0016.0	8x45(2x22.5 Cover)	360	375x135	12



Ref. Code	Yatay Masa Prizi Horizontal Desk Socket	a mm	Kesim Ölçüsü mm Cutting Dimension	
1740.1080.4020.1	4 Schuko + 2 Cat6	292.5	307,5x135	1



1740.1287.2211.0	2 Schuko + 2 UPS + 1 Cat6 + 1 Cat3	292,5	307,5x135	1
------------------	---------------------------------------	-------	-----------	---



1740.1280.2440.2	2 Schuko + 4 UPS + 4 Cat6	427,5	442,5x135	1
------------------	------------------------------	-------	-----------	---



1740.1280.3340.0	3 Schuko + 3 UPS + 4 Cat6	427,5	442,5x135	1
------------------	------------------------------	-------	-----------	---



G Type Desk Socket — G tipi Masa Grubu

- Masa üzerinde serbesttir ve sabitleyici bir aparat ile hızlıca tutturulur.
- Masanıza zarar vermez, kesim yapmanıza ya da vidalamanıza gerek yoktur.
- Her masada ve konumda rahatça kullanılır.

Free-standing with special fixation aparat.

Makes no harm on the desk, no need holes or screwdriving.

Regardless of location can be used on every desk.





- **G tipi kanal mutfaklarınızda raf ya da tezgah altlarında kullanılabilir.**
G type Socket can be installed in your kitchen under the cupboards or shelves.
- **G tipi Priz Grubu, Ofis ve Evde kullanılan çalışma masaları ve mutfaklar için çok uygundur.**
G desk Socket especially well suited to desks in offices and homes or kitchens.
- **LED modülü ile tezgah aydınlatması için kullanabilirsiniz.**
You can also use the LED module for bench lighting.
- **Güç, data ve multimedya soketlerine 45mm modüler prizlerin çeşitliliği ile sahiptir.**
Power, data and multimedia has an outstanding flexibility through use of 45mm Custom Modules.
- **Karşılaştırılabilir ürün: Bürtik Gruplar U62 & U42 (sayfa: 93-101)**
Compatible Product: Burotic Sockets U62 & U42 (page: 93-101)

G Tipi Priz / G Type Socket

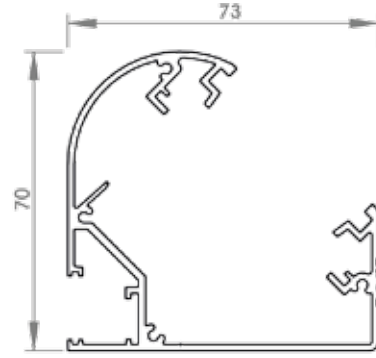
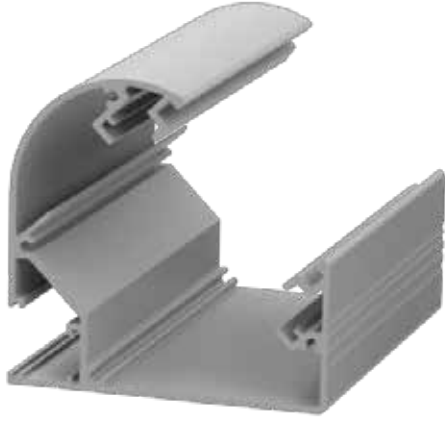

- **Grubu duvara ya da dolap kenarına basitçe monte edebilirsiniz.**
Simply adapt the power strip into your wall or cupboards.
- **İlk bağlantıda kablo klemensine kolay erişim sağlayan kapağı vardır.**
It has easy access covers for the first connection trough the cable terminal.
- **Tornavida yardımı ile alüminyum kapağı basitçe kaldırın, G tipi priz grubunu duvara vidalayın ve alüminyum kapağı bastırarak yerine takın.**
Take out aluminum cover with a screwdriver help, mount the G type socket on the wall with screws and place the cover by pushing.

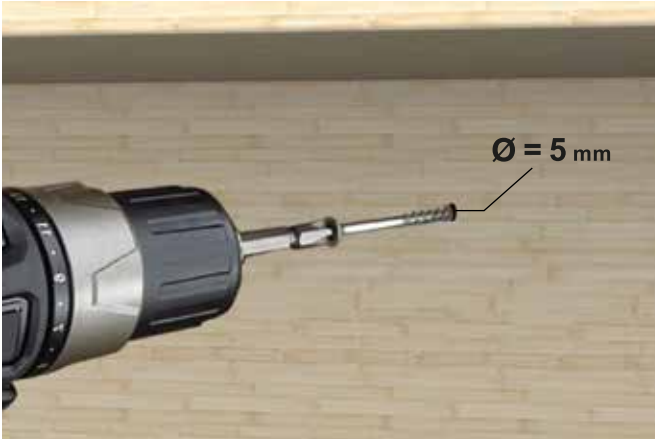

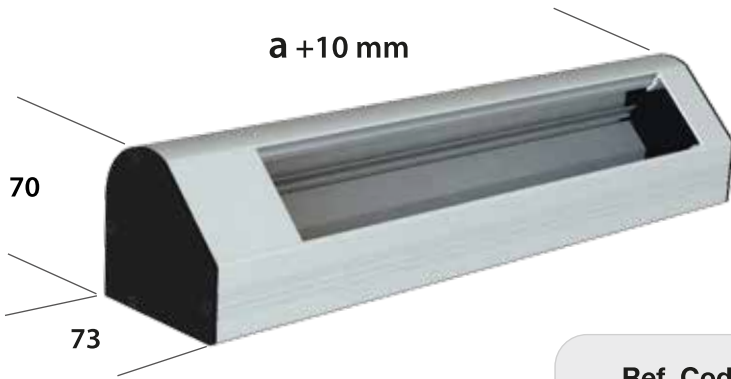

Ref. Code	Boş G Tipi Priz Empty G Type Socket	a mm	
1700.0000.0010.0	5x45(45+22.5 Cover)	225	1
1700.0000.0012.0	6x45(45+22.5 Cover)	270	1
1700.0000.0014.0	7x45(45+22.5 Cover)	315	1
1700.0000.0016.0	8x45(45+22.5 Cover)	360	1



Ref. Code	G Tipi Priz G Type Socket	a mm	
1700.2078.3011	3 UPS + 1 Cat6 + 1 Cat3	270	1



1700.1278.2211	2 Schuko + 2 UPS + 1 Cat6 + 1 Cat3	315	1
--------------------------------	------------------------------------	-----	---



1700.2678.3111	3 UPS + 1 Universal + 1 Cat6 + 1 Cat3	337,5	1
--------------------------------	---------------------------------------	-------	---



1700.2178.3111	3 UPS + 1 Cat6 + 1 Cat3 + 1 USB	292,5	1
--------------------------------	---------------------------------	-------	---



740.050.030	Montaj Ayağı / Mounting Aparat	30	1
740.050.070	Montaj Ayağı / Mounting Aparat	70	1

- Ayak aparatte: **a** miktarı maximum masa kalınlığı ölçüsüdür.
a is maximum mount of desk thickness for special fixation aparat.



Push-up Rising Socket



**Press down with your finger
to raise the handling then pull up**
Prizi açmak için kapağına bastırın ve yukarı çekin



PUSH-UP Rising Socket

- Modern görünüşle her alana uyum sağlar.
- Kurulumu çok basittir.
- Standart 60mm deliklere uygundur ve dar alanlarda ideal çözümdür.
- 60mm çapındaki deliğe yerleştirilir ve kilitleme yüzüğü çevrilerek monte edilir.

With a modern look, fits perfectly in any setting. Installation is very simple.

Suitable for standard 60 mm hole; ideal for tiny spaces.

Placed in a cut-out 60 mm in diameter and fixed to the furniture by turning the lock ring.

- Modüler yapısı sayesinde müşteri talepleri ile uluşturur.
Modules can be assembled to customer's needs.
- Elektrik prizleri, data telefon konnektörleri ve USB şarj cihazı monte edilebilir.
Power Sockets, RJ45 datas and telephone sockets and USB chargers are available modules.



Dikey Masa Prizi / Vertical Desk Socket



Ref. Code	Dikey Masa Prizi Vertical Desk Socket	a mm	Kesim Ölçüsü mm Cutting Dimension	
1800.1020.2010.0	2 Schuko + 2 USB Şarj	210	60 Ø	1

1800.2020.2010.0	2 UPS + 2 USB Şarj	210	60 Ø	1
----------------------------------	--------------------	-----	------	---

1804.1020.2010.0	2 Schuko + 2 USB Şarj + Gerilim koruma (SPD)	276	60 Ø	1
----------------------------------	---	-----	------	---

1804.2020.2010.0	2 UPS + 2 USB Şarj + Gerilim koruma (SPD)	276	60 Ø	1
----------------------------------	--	-----	------	---

U Tipi Grup Prizler / U type Power Strips

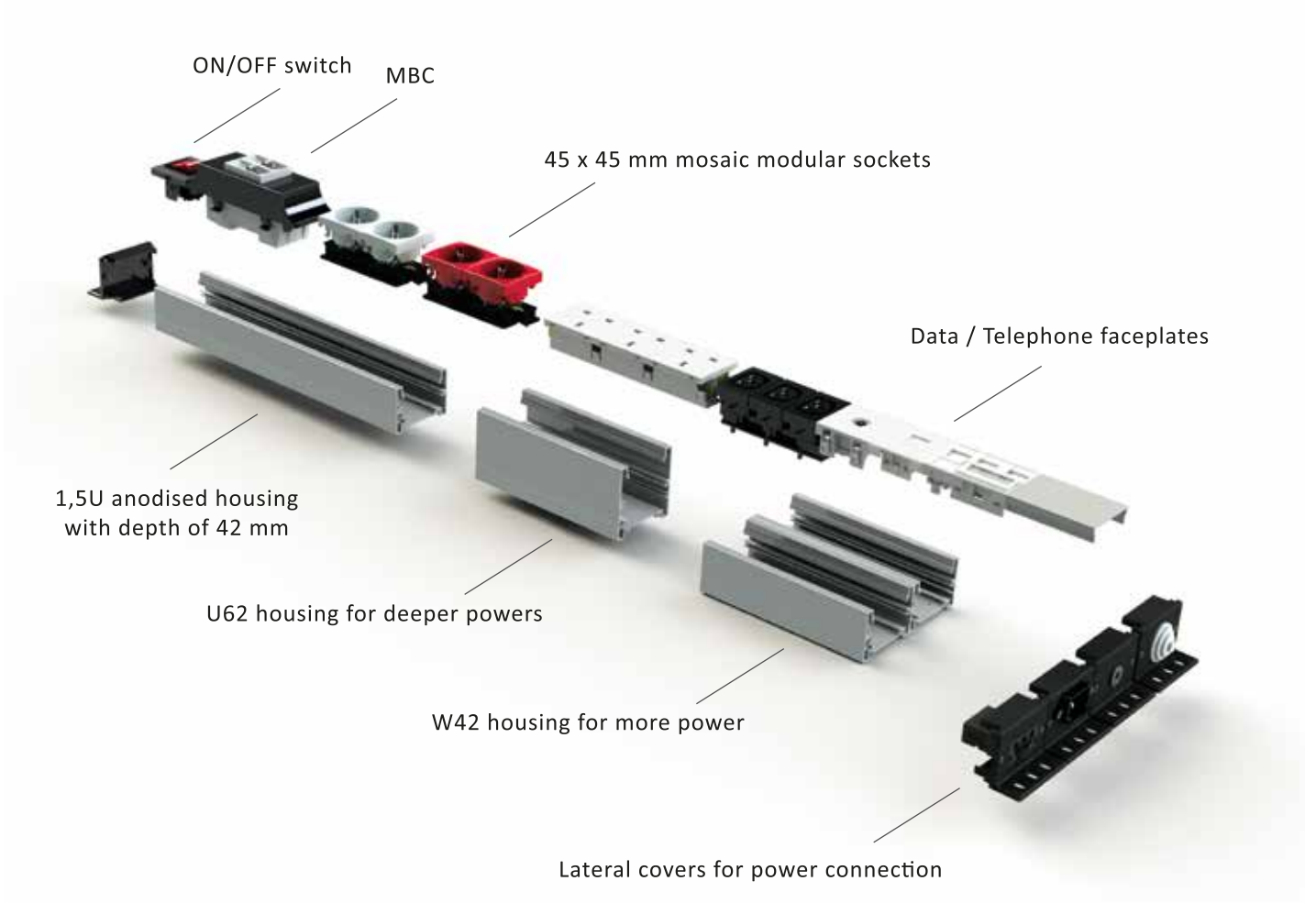

- **Tüm ihtiyaçları karşılayabilecek farklı uzunluklarda üretim imkanı.**
Opportunity to produce different lengths to meet every demand.
- **Modern ve modüler priz grubu tasarımları.**
Modern and Modular power strip designs.
- **Alüminyum gövdesi ile dekoratif görünüm.**
Decorative outlook with aluminium housing.
- **Gövdede delik açmadan güvenilir topraklama bağlantısı.**
Safe earth connection on housing without holes.
- **Farklı renklerde priz seçenekleri ile özel gruplar.**
Different Socket Outlet colors available for management.

Alüminyum Gövde tipleri: **U42, U62, W42, H62 (dikey ve yatay kullanım)**

Burotic Types : **U42, U62, W42, H62 (vertical and horizontal use)**

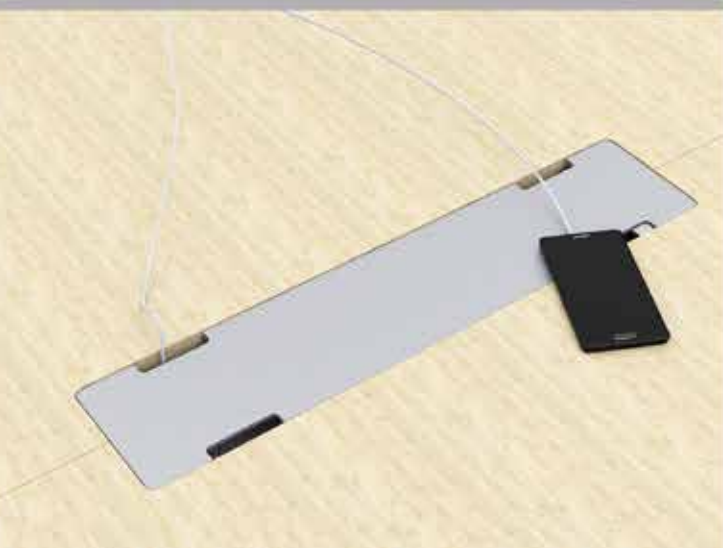

U42 Grup Prizler / U42 Power Strips



TEM PDU — Tight solution

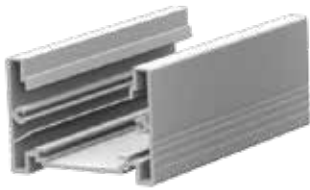

U42 Single Aluminium
U42 Tekli Alüminyum



U42 Single Plastic
U42 Plastik Tekli

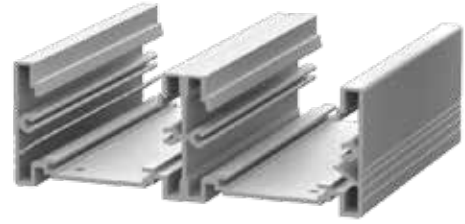

W42 Double Aluminium
W42 Çiftli Alüminyum

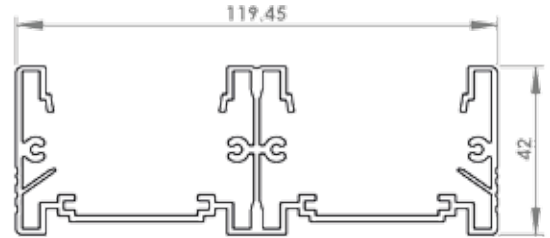
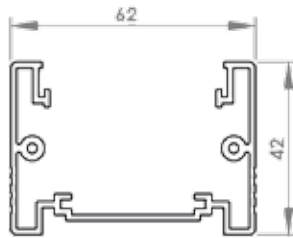
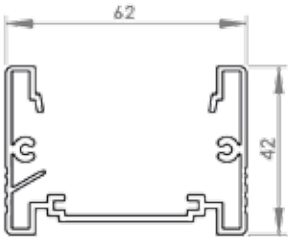

Farklı profil seçenekleri, çeşitli koruma tipleri ve soket elemanları ile **TEM PDU** size özel tasarım imkanı sağlar.

TEM PDU provides a customized design with its assorted housing types, various protection alternatives and connector modules.

U42 Grup Prizler / U42 Power Strips

U42 Priz Grupları / U42 Power Strips



Ref. Code	Standart Grup Standard Group	Ref. Code	Standart Grup Standard Group
X420.1000.6000.0	6 Schuko	X420.2000.6000.0	6 UPS
X420.1000.7000.0	7 Schuko	X420.2000.7000.0	7 UPS
X420.1000.8000.0	8 Schuko	X420.2000.8000.0	8 UPS
X420.1000.9000.0	9 Schuko	X420.2000.9000.0	9 UPS
X420.1000.10000.0	10 Schuko	X420.2000.10000.0	10 UPS



Ref. Code	Sigortalı Grup MCB Group	Ref. Code	Sigortalı Grup MCB Group
X421.1000.6000.0	6 Schuko + MCB	X421.2000.6000.0	6 UPS + MCB
X421.1000.7000.0	7 Schuko + MCB	X421.2000.7000.0	7 UPS + MCB
X421.1000.8000.0	8 Schuko + MCB	X421.2000.8000.0	8 UPS + MCB
X421.1000.9000.0	9 Schuko + MCB	X421.2000.9000.0	9 UPS + MCB
X421.1000.10000.0	10 Schuko + MCB	X421.2000.10000.0	10 UPS + MCB



Ref. Code	Anahtarlı Grup Switch Group	Ref. Code	Anahtarlı Grup Switch Group
X423.1000.6000.0	6 Schuko + Switch	X423.2000.6000.0	6 UPS + Switch
X423.1000.7000.0	7 Schuko + Switch	X423.2000.7000.0	7UPS + Switch
X423.1000.8000.0	8 Schuko + Switch	X423.2000.8000.0	8 UPS + Switch
X423.1000.9000.0	9 Schuko + Switch	X423.2000.9000.0	9 UPS + Switch
X423.1000.10000.0	10 Schuko + Switch	X423.2000.10000.0	10 UPS + Switch



Ref. Code	X420.1278.3211.0	X420.1278.2222.0	X420.1278.2312.0	X420.1278.3311.0
Özel Grubu Special Group	3 Schuko + 2 UPS + 1 Cat6 + 1 Cat3	2 Schuko + 2 UPS + 2 Cat6 + 2 Cat3	2 Schuko + 3 UPS + Cat6 + Cat3	3 Schuko + 3 UPS + Cat6 + Cat3

- X=1 Alüminyum gövde / Aluminum housing
- X=2 Plastik gövde / Plastic housing

W42 Grup Prizler / W42 Power Strips

W42 Alüminyum Priz Grupları / W42 Aluminum Power Strips



Ref. Code	Standart Grup Standard Group	Ref. Code	Standart Grup Standard Group
1430.1000.9000.0	9 Schuko	1430.2000.9000.0	9 UPS
1430.1000.12000.0	12 Schuko	1430.2000.12000.0	12 UPS
1430.1000.15000.0	15 Schuko	1430.2000.15000.0	15 UPS



Ref. Code	Sigortalı Grup MCB Group	Ref. Code	Sigortalı Grup MCB Group
1431.1000.9000.0	9 Schuko + MCB	1431.2000.9000.0	9 UPS + MCB
1431.1000.12000.0	12 Schuko + MCB	1431.2000.12000.0	12 UPS + MCB
1431.1000.15000.0	15 Schuko + MCB	1431.2000.15000.0	15 UPS + MCB



Ref. Code	Sigortalı Grup MCB Group	Ref. Code	Sigortalı Grup MCB Group
1433.1000.9000.0	9 Schuko + Switch	1433.2000.9000.0	9 UPS + Switch
1433.1000.12000.0	12 Schuko + Switch	1433.2000.12000.0	12 UPS + Switch
1433.1000.15000.0	15 Schuko + Switch	1433.2000.15000.0	15 UPS + Switch

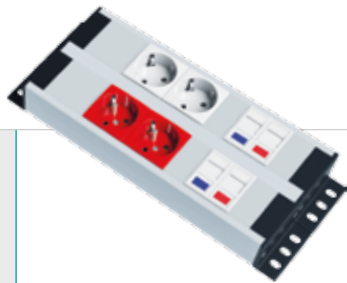

Ref. Code	1430.1278.2222.0	1430.1278.3211.0	1430.1278.2312.0
Özel Grubu Special Group	2 Schuko + 2 UPS + Cat6 + Cat3	3 Schuko + 2 UPS + Cat6 + Cat3	2 Schuko + 3 UPS + Cat6 + Cat3



Tongued Lateral Cover — Geçmeli Yan Kapak

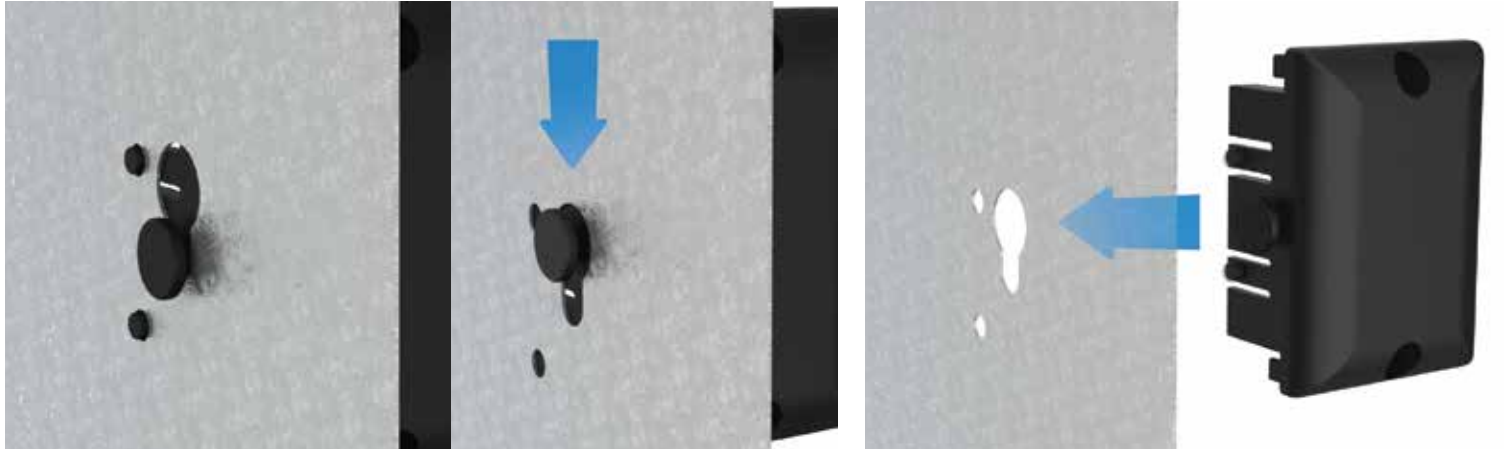

742.500.001
Closed Cover
Düz Kapak



742.512.011
Single Hole Cover
Tek Delikli Kapak



742.512.021
Double Hole Cover
İkili Delikli Kapak

U42 Yan Kapaklar / U42 Lateral Covers

Lateral Covers for U42 / U42 için Yan Kapaklar



742.000.001
Closed Cover
Düz Kapak



742.012.011
Single Hole Cover
Tek Delikli Kapak



742.012.021
Double Hole Cover
İkili Delikli Kapak



742.012.031
Triple Hole Cover
Üçlü Delikli Kapak



742.012.041
Plural Hole Cover
Çok Delikli Kapak



742.025.011
Cover with Hole for Gland
Rekor Delikli Kapak



742.025.111
Cover with Gland
Rekorlu Kapak



742.016.111
Cover with Screw Gland
Vidalı Rekorlu Kapak



742.090.011
Cover with Hole for Keystone
Konnektörlü Delikli Kapak



742.012.031
Cover with Locking Socket
Kilitli Soketli Kapak



742.014.211
Cover with Plug
Kilitli Kapak



742.014.231
Cover with Plug
Delikli & Kilitli Kapak



1628.10.00.5000.0

1620.12.78.2211.0

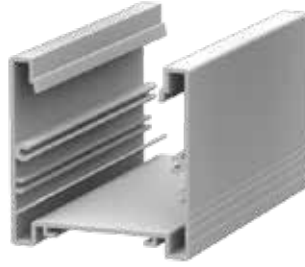

U62 Singel
U62 Tekli Derin

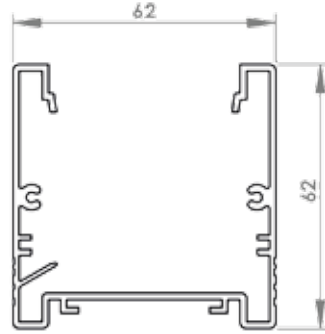

TEM U62 PDU — Deep Power Solution

- **Derin alüminyum gövde (62mm), prizlerin altından kablo geçmesi için yeterli alan verir.**
Deep aluminium housing (62mm), gives a space for cables under the sockets.
- **Görüntü, ses ve data konnektörleri gibi daha derin alana ihtiyaç duyan bağlantılar için idealdir.**
It is ideal housing for multimedia connectore where more space needs.

U62 Grup Prizler / U62 Power Strips

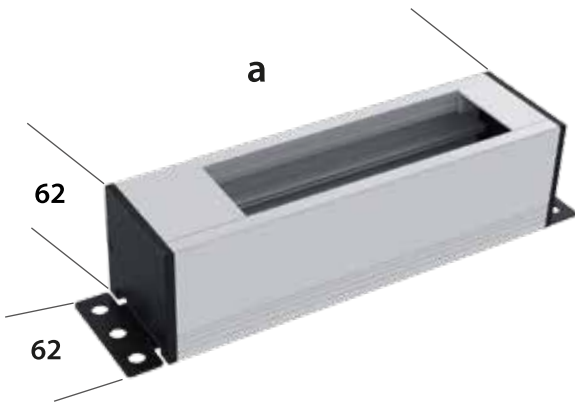

Ref. Code	Boş U62 Kanal Empty U62 PDU	a mm	
1620.0000.0010.0	5x45(45+22.5 Cover)	234	1
1620.0000.0012.0	6x45(45+22.5 Cover)	279	1
1620.0000.0014.0	7x45(45+22.5 Cover)	324	1
1620.0000.0016.0	8x45(45+22.5 Cover)	369	1
1620.0000.0018.0	9x45(45+22.5 Cover)	414	1
1620.0000.0020.0	10x45(45+22.5 Cover)	459	1



				
Ref. Code	1620.1278.2222.0	1620.1278.3211.0	1620.1278.3311.0	1620.1278.2312.0
Özel Grubu Special Group	2 Schuko + 2 UPS + 2 Cat6 + 2 Cat3	3 Schuko + 2 UPS + 1 Cat6 + 1 Cat3	2 Schuko + 3 UPS + 1 Cat6 + 1 Cat3	3 Schuko + 3 UPS + 2 Cat6 + 1 Cat3

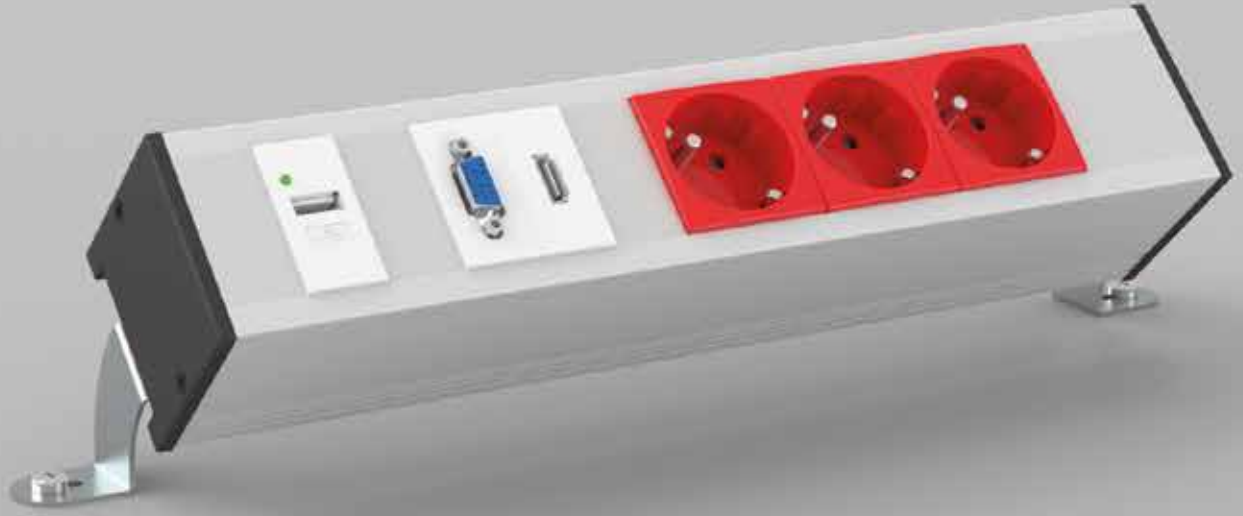

45° Metal Yan Aparat
45° Metal Side Aparatuse



Code: 762.900.002

Metal Yan Kulak
Metal Side Aparatuse



Code: 762.900.001

Düz Plastik Yan Kapak
Flat Plastic Lateral Cover



Code: 762.000.001

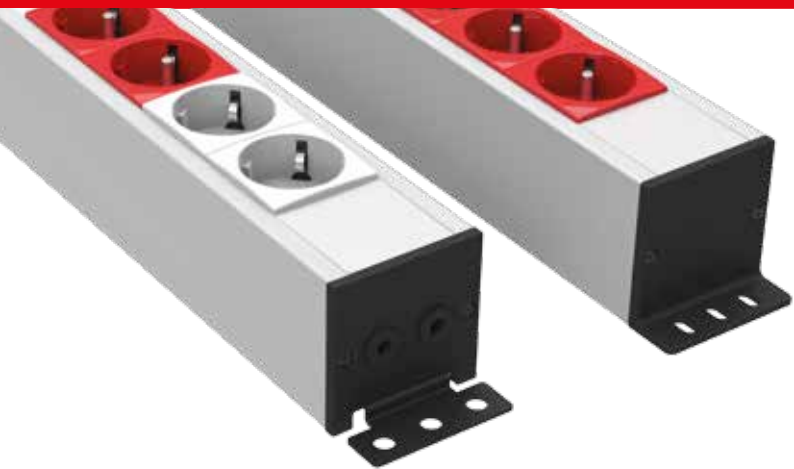

Plastik Tek Yön Yan Kapak
Plastic Single Side Lateral Cover



Code: 762.100.001

U62 Yan Kapaklar / U62 Lateral Covers



762.000.001
Closed Cover
Düz Kapak



762.025.011
Cover with Hole for Gland
Rekor Delikli Kapak



762.012.011
Single Hole Cover
Tek Delikli Kapak



762.012.021
Double Hole Cover
İkili Delikli Kapak



762.012.031
Triple Hole Cover
Üçlü Delikli Kapak



762.012.051
Plural Hole Cover
Çok Delikli Kapak



762.025.111
Cover with Gland
Rekorlu Kapak



762.025.121
Cover with Double Gland
Çift Rekorlu Kapak



762.029.111
Cover with Screw Gland
Vidalı Rekorlu Kapak



762.013.211
Cover with Socket
Kilitli Kapak



762.013.231
Cover with Socket & Single Hole
Delikli & Kilitli Kapak



762.014.211
Cover with Plug
Kilitli Kapak



762.014.221
Cover with Double Plug
Çift Kilitli Kapak



762.020.311
Cover with Locking Socket
Kilitli Soketli Kapak



762.020.321
Cover with Double Locking Socket
Çift Kilitli Soketli Kapak



TEM Powers — Your Industrial Needs

TEM PDU farklı profil seçenekleri, modüler enerji, multimedya konnektörleri ile endüstriyel çözümler sunar. TEM PDU, sağlam alüminyum gövdesi, şık tasarımı ve modüler yapısı ile her alanda kullanılabilir.

TEM Powers, developing special solution for customers with its various protection alternatives and connector modules.

With the solid alüminyum housing, elegant design and modulaire structure, It present solutions in every area.



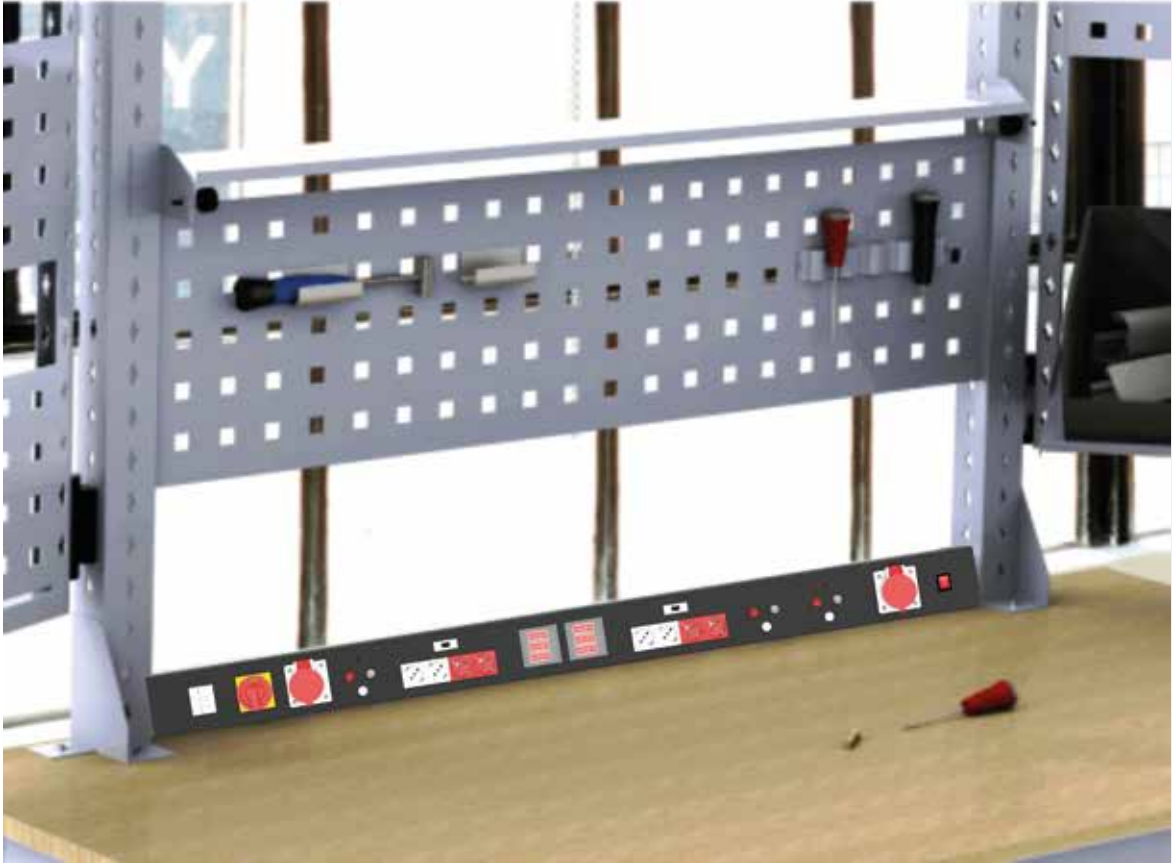

- Her çalışma alanında elektrik ihtiyacı vardır.
- TEM müşterilerine özel çözümler geliştirir ve imal eder.
- 45mm modüler komponentler ile farklı ülke prizleri uygulanabilir.

Every work place needs power.

TEM is manufacturing special solution for its customers.

With the 45mm mosaic components, different national sockets can be used.



TEM Vertical Power Frame

- TEM Dikey Kolon prizlerin ayakları boyalı metalden yapılmıştır.
- Bu yuvarlak metal ayak sayesinde kolay ve güvenli bir şekilde sabitlenir.
TEM Vertical Column Powers free standing base made of colored metal.
Easily and securely can fixed by this cycle metal base.
- Yerde duran güç çözüm olarak evde, ofiste ya da bekleme salonunda kullanabilir.
It can be a free-standing power solution for home, offices or waiting areas.

Kolon / Column

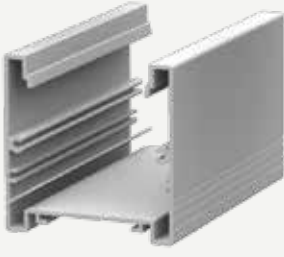

U62 Singel
U62 Tekli Derin



H62 Double
H62 Çiftli



H100 Double
H100 Çiftli

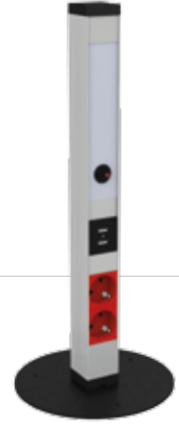

				
Ref. Code	1102.1287.4444*	1103.3531.6111*	1105.1269.2211*	1405.1020.2100
Açıklama Description	2 (2 Schuko + 2 UPS + 2 Cat6 + 2 Cat3 + 2 MCB) H Double Column	2 (4 IEC Prizi + 1 HDMI + 1 USB Charger + 1 RCA + ON/OFF Switch) H Double Column	2 (2 Schuko + 2 UPS + 1 RCA + 1 TV Socket + Switch) H Double Column	2 Schuko + 3 UPS + 2 USB Charger + 1 LED 1U Single Column



				
Ref. Code	1626.1276.2211	1626.0235.3111	1627.0213.422*	1627.0401.62*
Açıklama Description	2 Schuko + 2 UPS + 2 Cat6 + 2 Cat3 Single Column	3 UPS + 1 USB Şarj + 1 VGA + 1 HDMI Single Column	2 UPS + 1 USB Şarj + 1 HDMI Double Column	3 British Prizi + 1 USB Charger Double Column

- **TEM Kolon** esnek çözüm olarak farklı yerlerde kullanmak için kolayca taşınabilir.
TEM Column is a free-standing product, can move as a flexible solution.
- Uygun yüksekliği ile prizler, data ve multimedya modüller daha kullanışlıdır.
Sockets, Data and Multimedia modules are available at a convenient height.
- Evinizde dekoratif ve güzel görünür.
It is a decorative product and good -look at view for your room.



- Tüm bekleme alanlar için uygun çözümdür.

Havaalanları, Terminaller, Otel Lobileri ve Hastanelerde çokça kullanılmaktadır.

It is a good power solution for every waiting area; mostly used in terminals, hotels, hospitals and charging stands.

Kablosuz şarj edilebilir.
Wireless chargeable.





1U Power Strip — Unique Smart Design

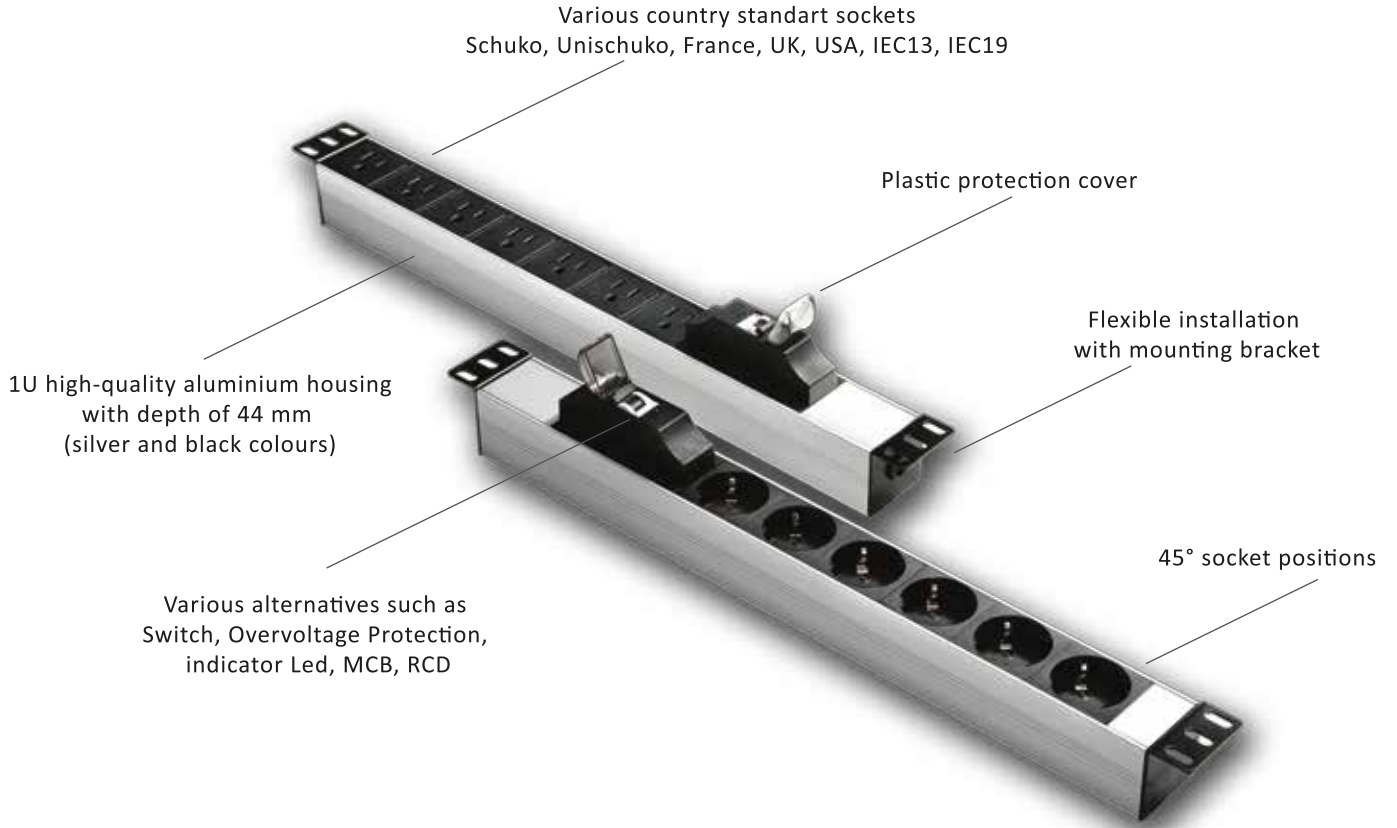

Space-Saving Integration of PDU in the Server Cabinet

- **19" data kabinlerinde 9 schuko prize kadar yatay kapasite.**
Horizontal Power capacity for 19" data racks up to 9 schuko sockets.
- **Led ışık modülü eklentisi.**
Led light integration to power strip.
- **Bağlı cihazların güvenliği için çeşitli koruma seçenekleri.**
Various alternatives for protection of the devices.
- **Dünya standartlarına uygunluk.**
Compliance with international standards.

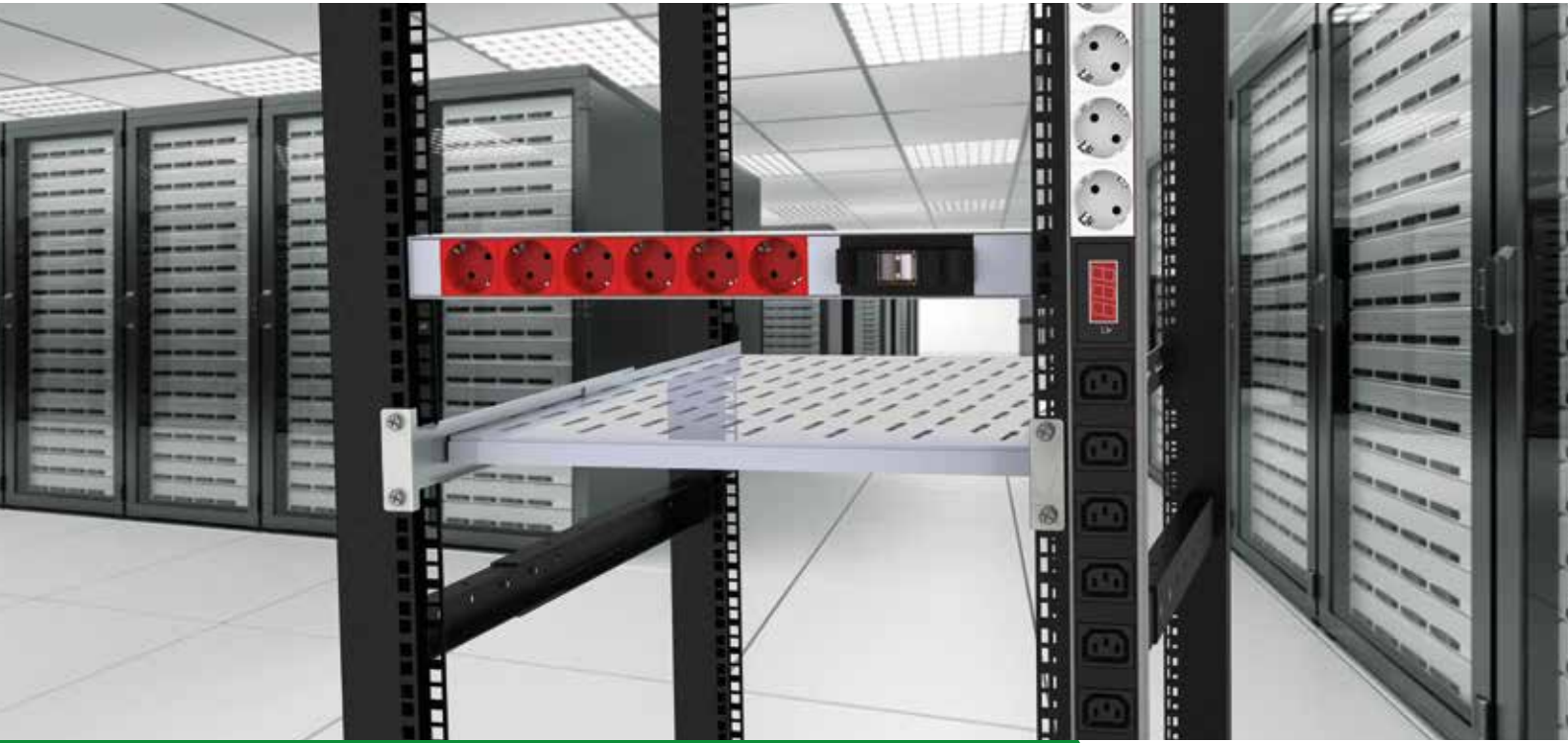

1U Single Aluminium
1U Tekli Alüminyum



1U Single Plastic
1U Tek Plastik



2U Double Aluminium
2U Çift Alüminyum

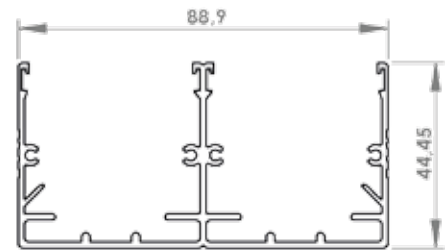
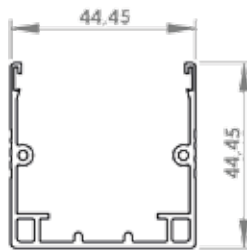
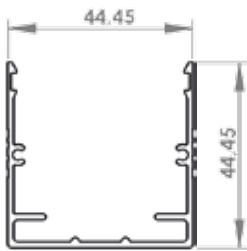

- Server ve Network kabinler için özel çözümler.
- Yüksek güç gerektiren kabinlere güç beslemesi.
- Üç ayrı sigortalı devreye 3 faz güç bağlantısı.

Customised solutions for Server and Network Racks.

Power supply for control cabinets with high power requirements.

Option of 3-phase power with three separate circuits.



1404.10.00.4000.0

1408.20.00.6000.0

- 18U, 36U ve 42U boy kabinlerde dikey priz uygulamaları.
Vertical applications for 18U, 36U or 42U.
- PDU için gömme dijital ampermetre ve voltmeter takılabilir. Ampermetre ve voltmeter anlık olarak enerji kullanımını okur ve gösterir.
The digital ampermeter and voltmeter allows for a direct and current readout of amp & volt usage.
- Master & Slave modülü entegre edilmiş gruplar işinizi birbirleri ile ilişkili olarak yönetmenizi sağlar.
Master & Slave circuit integrated power strip helps to control the business in relation with each other.

1U Alüminyum Priz Grupları / 1U Aluminum Power Strips



Ref. Code	Standart Grup Standard Group	Ref. Code	Standart Grup Standard Group
X400.1000.6000.0	6 Schuko	X400.2000.6000.0	6 UPS
X400.1000.7000.0	7 Schuko	X400.2000.7000.0	7 UPS
X400.1000.8000.0	8 Schuko	X400.2000.8000.0	8 UPS
X400.1000.9000.0	9 Schuko	X400.2000.9000.0	9 UPS
X400.1000.10000.0	10 Schuko	X400.2000.10000.0	10 UPS



Ref. Code	Sigortalı Grup MCB Group	Ref. Code	Sigortalı Grup MCB Group
X401.1000.6000.0	6 Schuko + MCB	X401.2000.6000.0	6 UPS + MCB
X401.1000.7000.0	7 Schuko + MCB	X401.2000.7000.0	7 UPS + MCB
X401.1000.8000.0	8 Schuko + MCB	X401.2000.8000.0	8 UPS + MCB
X401.1000.9000.0	9 Schuko + MCB	X401.2000.9000.0	9 UPS + MCB
X401.1000.10000.0	10 Schuko + MCB	X401.2000.10000.0	10 UPS + MCB



Ref. Code	Anahtarlı Grup Switch Group	Ref. Code	Anahtarlı Grup Switch Group
X403.1000.6000.0	6 Schuko + Switch	X403.2000.6000.0	6 UPS + Switch
X403.1000.7000.0	7 Schuko + Switch	X403.2000.7000.0	7 UPS + Switch
X403.1000.8000.0	8 Schuko + Switch	X403.2000.8000.0	8 UPS + Switch
X403.1000.9000.0	9 Schuko + Switch	X403.2000.9000.0	9 UPS + Switch
X403.1000.10000.0	10 Schuko + Switch	X403.2000.10000.0	10 UPS + Switch

- X=1 Alüminyum gövde / Aluminum housing X=2 Plastik gövde / Plastic housing

W1U Alüminyum Priz Grupları / W1U Aluminum Power Strips



Ref. Code	W1U Grup W1U Group	Ref. Code	W1U Grup W1U Group
1410.1000.12000.0	12 Schuko	1410.2000.12000.0	12 UPS
1411.1000.9000.0	9 Schuko + MCB	1411.2000.9000.0	9 UPS + MCB
1411.1000.12000.0	12 Schuko + MCB	1411.2000.12000.0	8 UPS + MCB
1413.1000.12000.0	12 Schuko + 2 Switch	1413.2000.12000.0	12 UPS + 2 Switch

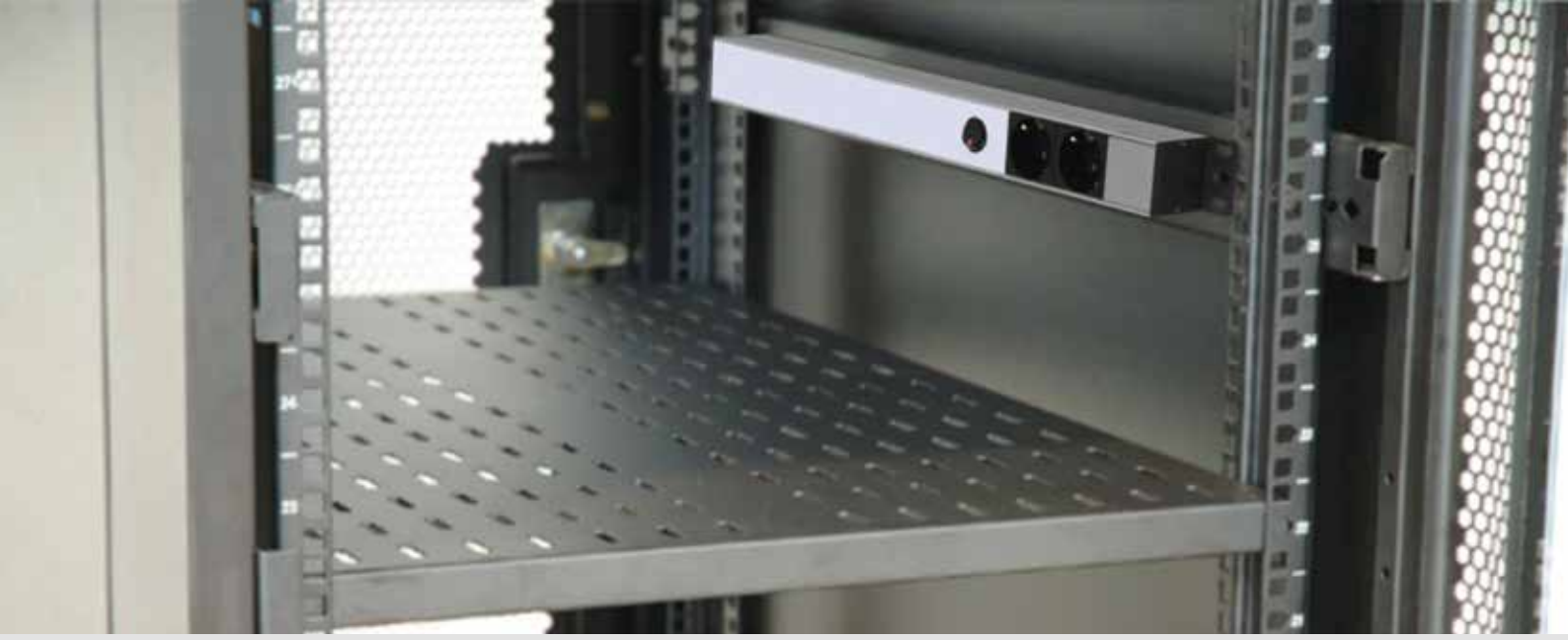

- **1U aydınlatma Rack içinde ihtiyaç duyulan her yerde kullanılabilir.**
1U Lighting, can be mount on every work side of Rack where its need.
- **Aydınlatma modülü, diğer priz seçenekleri kombine edilebilir.**
It can be combined with light module and the sockets options.
- **1U Aydınlatmada anahtar ve sensör modülleri opsiyoneldir.**
There is switch and sensor optional modules in lights design.

Flexible Lateral Cover — Dönerli Yan Kapak



Ref. Code: 743.410.011



Ref. Code: 743.450.001

- Metal Montaj kulağı sayesinde farklı açılarda ve yüksekliklerde montaj yapmak mümkündür.
Fixed at different heights and angles with the use of the metal mounting bracket.
- Plastik kapakta bulunan kademelere, metal kulağı yerleştirerek kolayca montaj yapabilirsiniz.
Very easy to fix the PDU by inserting the metal bracket in to the slots of the plastic end cap.

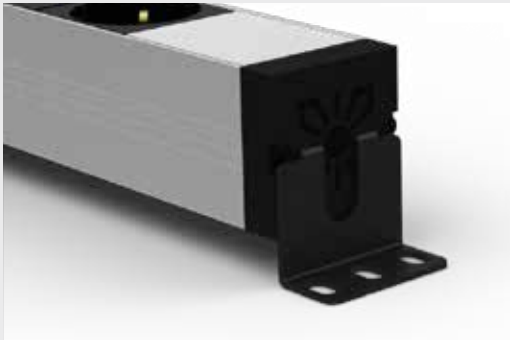
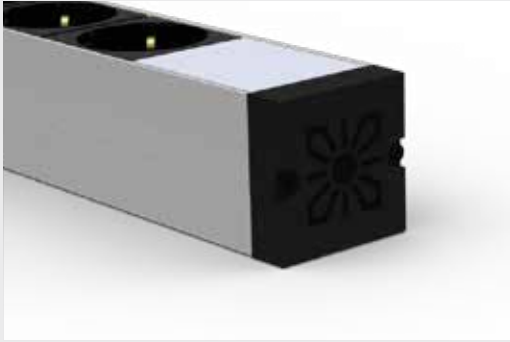

1U GST Soket Girişli — Eklenebilir Priz Grupları



Dişi GST Soket Girişli
Yan Kapak
Cover with Female GST Socket



Code: 743.600.001

Erkek GST Soket Girişli
Yan Kapak
Cover with Male GST Plug



Code: 743.650.001



Plastik Tek Yön Yan Kapak
Plastic Single Side Lateral Cover



Code: 743.200.001

Metal Yan Kapak
Metal Lateral Cover



Code: 743.500.001

Plastik Yan Kapak
Plastic Lateral Cover



Code: 743.100.001

Düz Plastik Yan Kapak
Flat Plastic Lateral Cover



Code: 743.300.001

Schuko Prizi
/ Schuko socket
305.216.001



UPS Prizi
/ Unischuko socket
305.316.001



IEC C13 10A Prizi
/ IEC C13 10A
325.313.001



IEC C19 16A Prizi
/ IEC C19 16A
325.319.001



İngiliz Prizi
/ BS socket
316.313.101



Amerikan Prizi
/ USA socket
316.310.001



LED Sinyal Işıđı
/ LED Light indicator
743.614.015

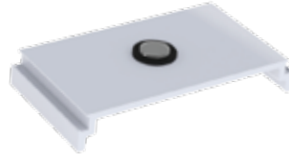

ON-OFF Anahtar
ON/OFF Switch
743.613.011



Gerilim Koruma
/ SPD (Surge Protective Device)
734.612.011



USB Şarj
/ USB Charger
743.610.021



MASTER & SLAVE
743.611.011



İkili CAT 6
/ Double CAT6
743.100.107



Tekli Sigorta Kutusu
/ Singel MCB Box
743.600.011



İkili Sigorta Kutusu
/ Double MCB Box
743.600.021



Some Samples of Power Accessories
Çüç Aksesuarları Örnekleri



LED illuminated power indicator
LED güç göstergesi



SPD surge protection device
Gerilim Koruma



master slave module



iluminated switch 10-16A
ışıklı anahtar 10-16A



Emergency Stop
Acil Stop



mcb circuit breaker
Sigorta



Double MCB or RCB Residual Current Breaker
çift sigorta ya da kaçak akım



EAmperemeter,
Voltmeter, Multimeter

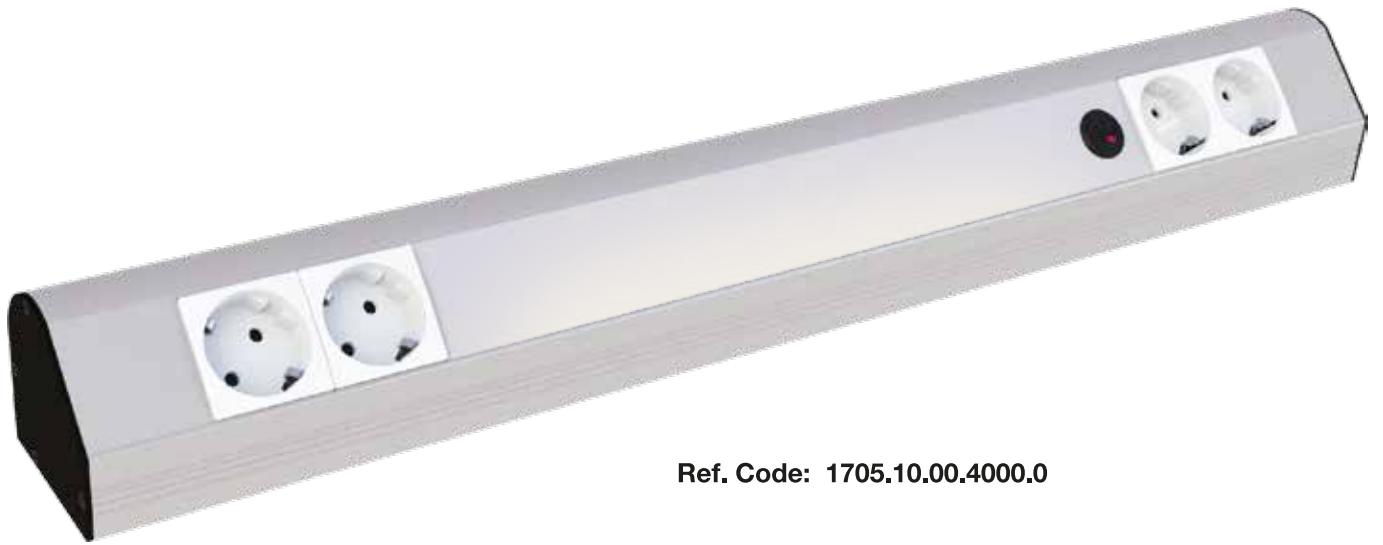

Ref. Code: 1705.10.00.4000.0

- **Aydınlatma ve priz seçenekleri kombine edilebilir.**
It can be combination of light and sockets options.
- **Miknatis, vida ve özel yan kapaklar ile kolayca monte edilebilir.**
Can installed easily by optional lateral cover with screw or magnet installation.
- **Anahtar ve sensör uygun opsiyonel modüllerdir.**
Switch and sensor are available optional modules.

U20 Lighting Grup / U20 Aydınlatma Grubu

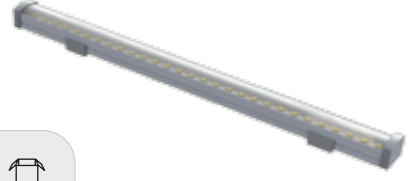

Ref. Code	Lineer LED Armatürleri Liner Lighting Grup	
120X.2420.436	24V 1m with Cable + 20cm 4.3W 360 Lumen	1
120X.2430.436	24V 1m with Cable + 30cm 4.3W 360 Lumen	1
120X.2450.760	24V 1m with Cable + 50cm 7.2W 600 Lumen	1
120X.2410.1436	24V 1m with Cable + 100cm 14.1W 360 Lumen	1
120X.2230.540	220V 1m with Cable + 35cm 5W 400 Lumen	1
120X.2240.648	220V 1m with Cable + 41cm 6W 480 Lumen	1
120X.2251.080	220V 1m with Cable + 52cm 10W 800 Lumen	1

- X=0 - Mıknatıssız / without Magnet X=1 - Mıknatıslı / with Magnet

1U Lighting Grup / 1U Aydınlatma Grubu

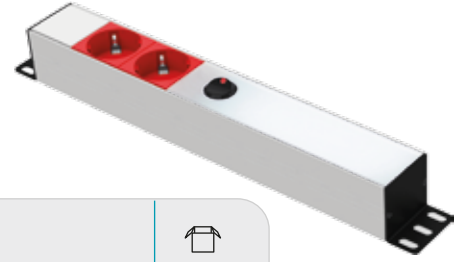

Ref. Code	1U Aydınlatma Grubu 1U Lighting Grup	
14X5.1000.2000.1	220V 2Schuko + 32 cm Profil + 13cm LED + 2m x 3x1.5 H05VV-F	1
14X10.1000.2000.1	220V 2Schuko + 32 cm Profil + 13cm LED + 2m x 3x1.5 HO5VV-F Cable for Switch	1
14X9.1000.2000.1	220V 2Schuko + 32 cm Profil + 13cm LED + 2m x 3x1.5 H05VV-F + Sensor	1

- X=0 - Mıknatıssız / without Magnet X=1 - Mıknatıslı / with Magnet

G Type Lighting Grup / G Tipi Aydınlatma Grubu



Ref. Code	G Tipi Aydınlatma Grubu G Type Lighting Grup	
1705.1000.2000.0	220V 53 cm - 2 Schuko + 30cm 16W LED with Switch	1
1705.1000.2000.0	220V 45 cm - 2 Schuko + 13cm 8W LED with Switch	1
1705.1000.6000.0	220V 71.5 cm - 6 Schuko + 2x30cm 16W LED with Switch	1
17035.1000.2000.0	220V 41 cm - 2 Schuko + Anahtar + 15cm boy 8W LED with Switch	1
17035.1000.4000.0	220V 67 cm - 4 Schuko + Anahtar + 30cm 16W LED with Switch	1
1709.1000.2000.0	220 V 62 cm - 2 Schuko + 30cm 16W LED with Sensor	1

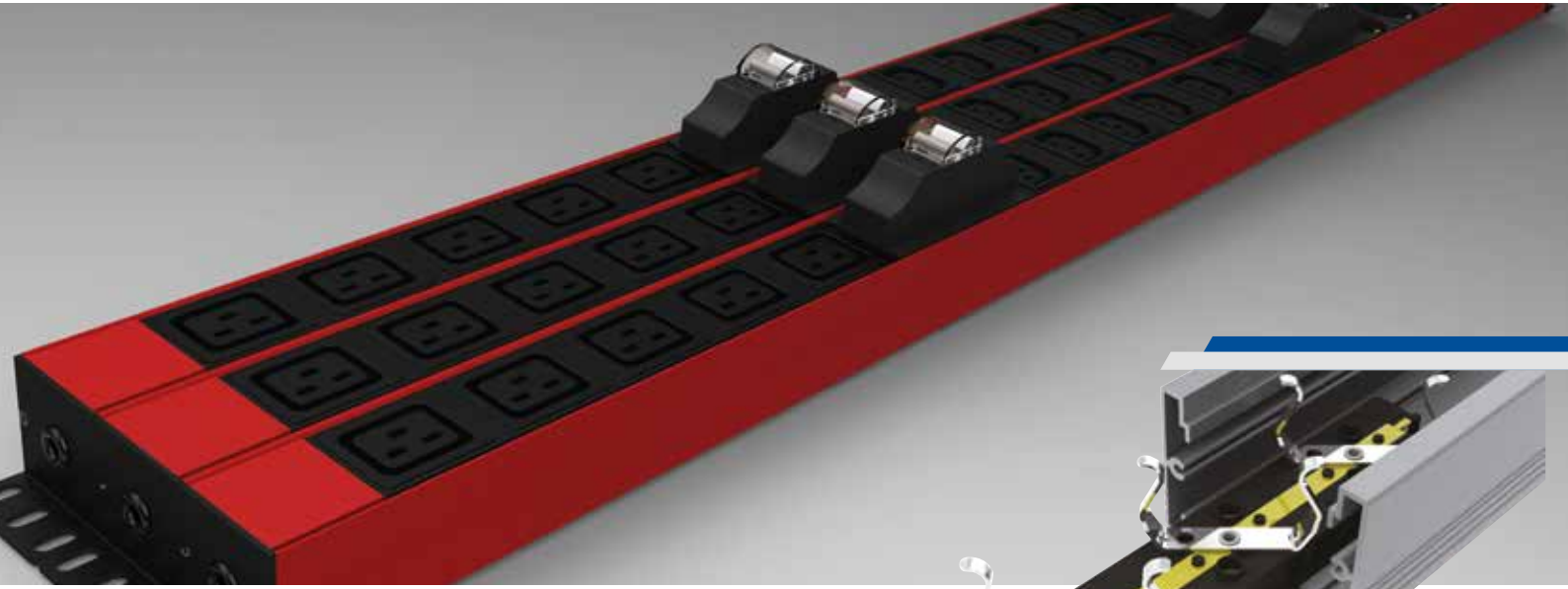

Sockets for Cable Trunkings

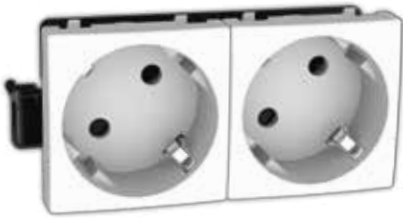

Şebeke Prizleri
Schuko Sockets



UPS Prizleri
Unischuko Sockets



İngiliz Prizleri
British Standard Sockets

- **Ürünlerimizin modüler yapısı sayesinde ihtiyaca yönelik gruplar tasarlayabilirsiniz.**
With the modularity of our products, you can design personal strips.
- **TEM çoklu prizlerde bara sistemi vardır, aynı modüllerde kablo bağlantısına gerek yoktur.**
TEM multiple sockets has busbar system, no need to connect cable between the same modules.
- **Prizlerin bir ya da iki tarafından klemensli olma opsiyonu vardır.**
There is the option of the sockets to have cable terminal on one or both side.

Kanal Üstü Şebeke Prizi / Schuko Socket for Cable Trunkings (w-earth)

Şebeke Grup Prizleri / Schuko Group Sockets



Kablo Girişli Şebeke Prizi
Schuko Socket with Cable



Klemens Girişli Şebeke Prizi
Schuko Socket with Terminal



Çift Klemens Girişli Şebeke Prizi
Schuko Socket with Double Terminal

200-250V
16A
2P+⏏
IEC 61643-1

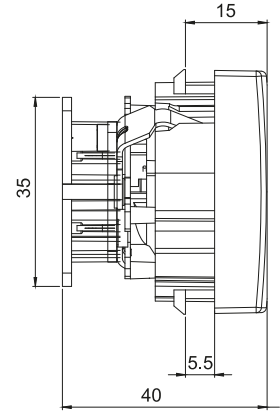
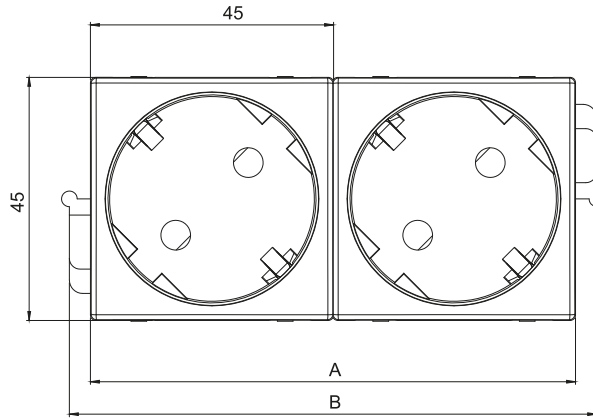

	Ref. Code	Ref Code with child protection	Ref. Code	A	B		
							gr.
	300.216.002	300.216.102	Kablo girişli With cable	90	97.5	20	61
	301.216.002	301.216.102	Klemens girişli With terminal	90	113.7	20	68
	302.216.002	302.216.102	Çift klemens girişli With double terminal	90	128.9	20	81
	300.216.003	300.216.103	Kablo girişli With cable	135	142.5	15	93
	301.216.003	301.216.103	Klemens girişli With terminal	135	157.7	15	97
	302.216.003	302.216.103	Çift klemens girişli With double terminal	135	172.9	15	109
	300.216.004	300.216.104	Kablo girişli With cable	180	187	14	119
	301.216.004	301.216.104	Klemens girişli With terminal	180	202.2	14	127
	302.216.004	302.216.104	Çift klemens girişli With double terminal	180	217.4	10	139

Kanal Üstü UPS Prizi / Socket for Cable Trunkings (UPS)

UPS Grup Prizleri / Unischuko Group Sockets

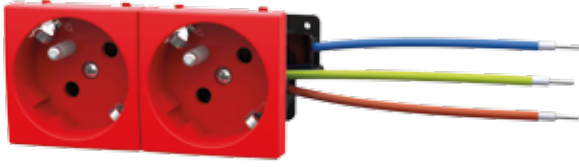

Kablo Girişli UPS Prizi
Unischuko Socket with Cable



Klemens Girişli UPS Prizi
Unischuko Socket with Terminal

200-250V

16A

2P+⏚

IEC 61643-1



Çift Klemens Girişli UPS Prizi
Unischuko Socket with Double Terminal

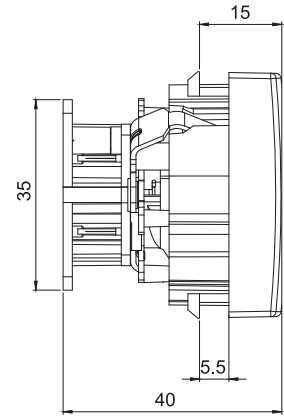
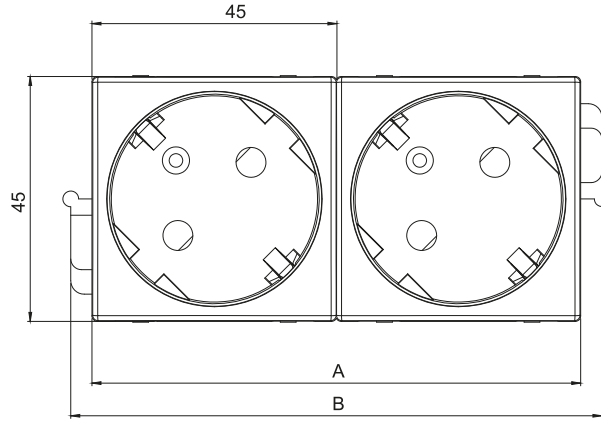

	Ref. Code	Ref Code with child protection	Ref. Code	A	B		
							gr.
	300.316.002	300.316.102	Kablo girişli With cable	90	97.5	20	68
	301.316.002	301.316.102	Klemens girişli With terminal	90	113.7	20	75
	302.316.002	302.316.102	Çift klemens girişli With double terminal	90	128.9	20	87
	300.316.003	300.316.103	Kablo girişli With cable	135	142.5	15	100
	301.316.003	301.316.103	Klemens girişli With terminal	135	157.7	15	107
	302.316.003	302.316.103	Çift klemens girişli With double terminal	135	172.9	15	119
	300.316.004	300.316.104	Kablo girişli With cable	180	187	14	131
	301.316.004	301.316.104	Klemens girişli With terminal	180	202.2	14	138
	302.316.004	302.316.104	Çift klemens girişli With double terminal	180	217.4	10	150

Kanal Üstü Fransız Prizi / Socket for Cable Trunkings (French)

Fransız Grup Prizleri / French Group Sockets

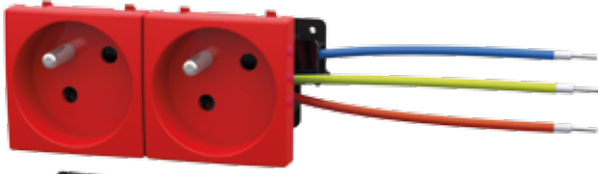

Kablo Girişli Fransız Prizi
French Socket with Cable



Klemens Girişli Fransız Prizi
French Socket with Terminal

200-250V

16A





2P+⏏

NF C 61-314

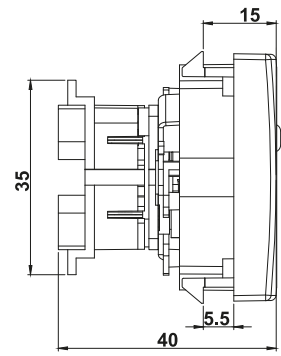
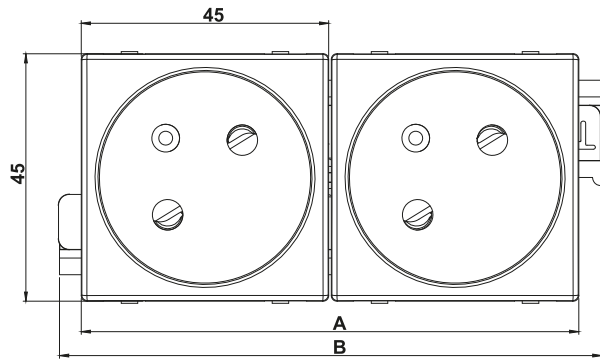

Çift Klemens Girişli Fransız Prizi
French Socket with Double Terminal



	Ref. Code	Ref Code with child protection	Ref. Code	A	B		 gr.
	310.316.002	310.316.102	Kablo girişli With cable	90	97.5	20	65
	311.316.002	311.316.102	Klemens girişli With terminal	90	113.7	20	72
	312.316.002	312.316.102	Çift klemens girişli With double terminal	90	128.9	20	82
	310.316.003	310.316.103	Kablo girişli With cable	135	142.5	15	95
	311.316.003	311.316.103	Klemens girişli With terminal	135	157.7	15	102
	312.316.003	312.316.103	Çift klemens girişli With double terminal	135	172.9	15	114
	310.316.004	310.316.104	Kablo girişli With cable	180	187	14	125
	311.316.004	311.316.104	Klemens girişli With terminal	180	202.2	14	133
	312.316.004	312.316.104	Çift klemens girişli With double terminal	180	217.4	10	144

Kanal Üstü İngiliz ve Bilgisayar Prizleri / British & IEC C13 Sockets

İngiliz Grup Prizleri / British Group Sockets

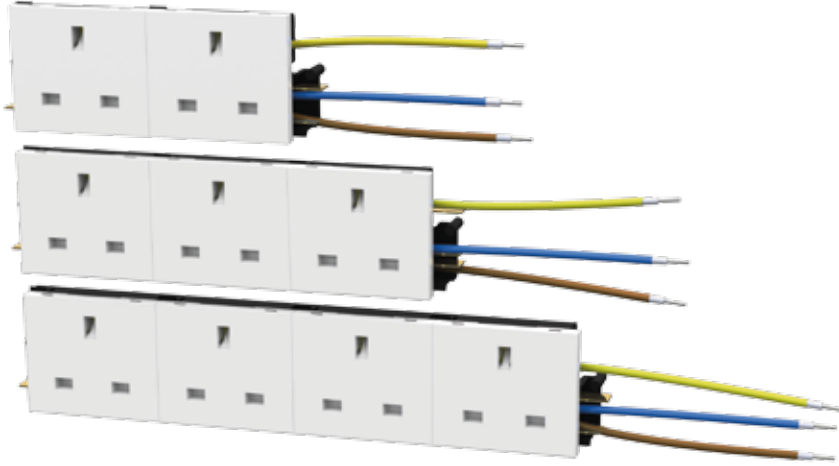

200-250V
13A
2P+⏏
BS 1363

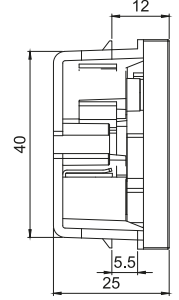

Ref. Code		A	B		gr.
315.313.102	Kablo giriřli With cable	90	111	30	60
315.313.103	Kablo giriřli With cable	135	161	30	90
315.313.104	Kablo giriřli With cable	180	211	30	115

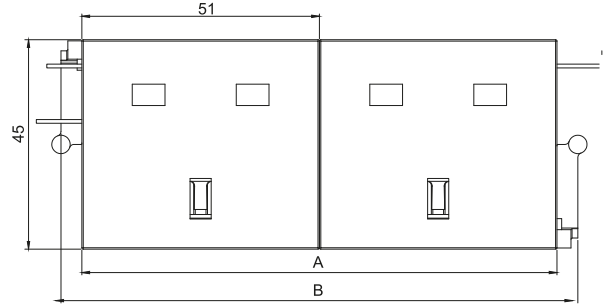

Bilgisayar Grup Prizleri / IEC Group Sockets

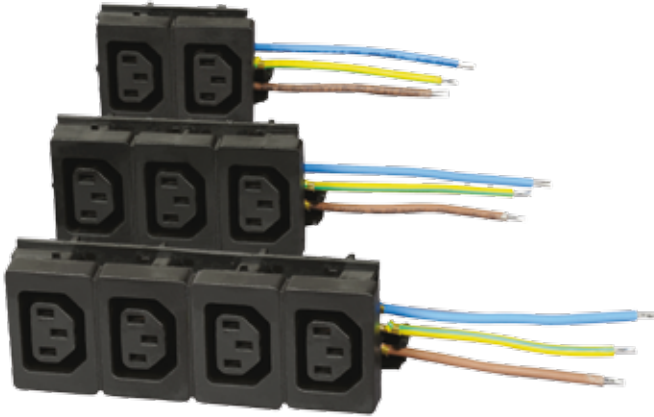

200-250V
10A
2P+⏏
IEC 320

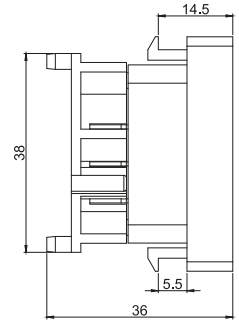

Ref. Code		A	B		gr.
320.310.002	Kablo giriřli With cable	60	70	30	59
320.310.003	Kablo giriřli With cable	90.5	101	30	82
320.310.004	Kablo giriřli With cable	121	132	30	108.4

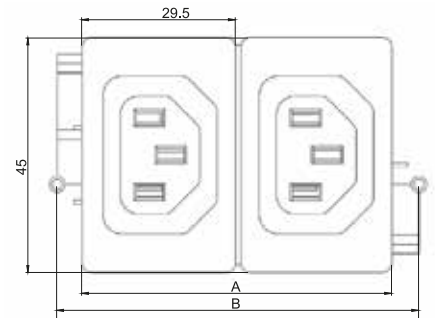

Kanal Üstü Şebeke Prizleri / Schuko Sockets for Cable Trunkings

Tekli Şebeke Prizi Çift Klemensli Singel Schuko socket with Double Terminal



200-250V
16A
2P+⏚

	Ref. Code		 gr.
Düz kontak straight posture	345.216.150	60	41
45° kontak 45° posture	346.216.150	60	43
Düz kontak çocuk kilitli straight posture with child protection	345.216.250	60	43
45° kontak çocuk kilitli 45° posture with child protection	346.216.250	60	45

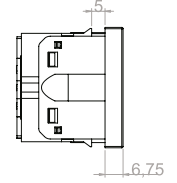
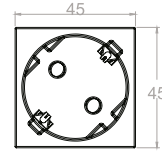
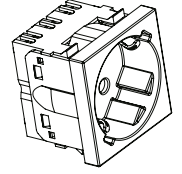
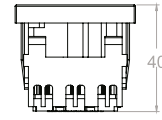

Tekli Şebeke Prizi Tek Klemensli Singel Schuko socket with Single Terminal



200-250V
16A
2P+⏚

	Ref. Code		 gr.
Düz kontak straight posture	245.216.150	60	34
45° kontak 45° posture	246.216.150	60	34
Düz kontak çocuk kilitli straight posture with child protection	245.216.250	60	36
45° kontak çocuk kilitli 45° posture with child protection	246.216.250	60	36

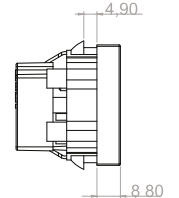
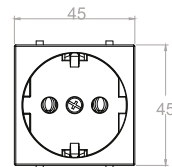
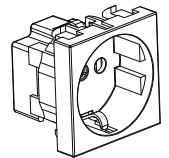
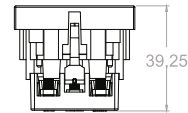

Tekli UPS Prizi Çift Klemensli Singel Unischuko sockets with Double Terminal



200-250V
16A
2P+⏚

	Ref. Code		 gr.
Düz kontak straight posture	345.316.150	60	45
45° kontak 45° posture	346.316.150	60	46
Düz kontak çocuk kilitli straight posture with child protection	345.316.250	60	47
45° kontak çocuk kilitli 45° posture with child protection	346.316.250	60	48

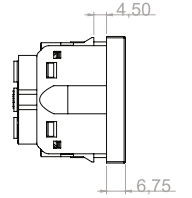
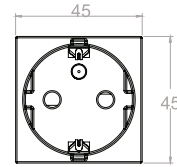
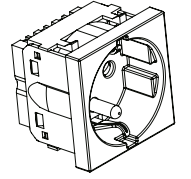
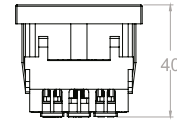

Tekli UPS Prizi Tek Klemensli Singel Unischuko sockets with Single Terminal



200-250V
16A
2P+⏚

	Ref. Code		 gr.
Düz kontak straight posture	245.316.150	60	38
45° kontak 45° posture	246.316.150	60	38
Düz kontak çocuk kilitli straight posture with child protection	245.316.250	60	40
45° kontak çocuk kilitli 45° posture with child protection	246.316.250	60	40

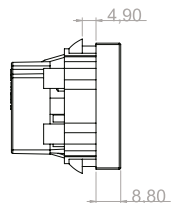
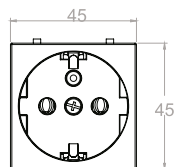
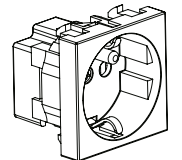
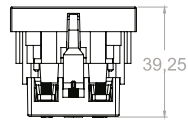

Çeşitli Priz Standartları / International sockets



247.216.150
Fransız Prizi
French Socket



721.160.150
Amerikan Prizi
USA Socket



721.130.150
İngiliz Prizi
BS Socket



721.130.160
İngiliz Prizi
BS Socket



721.170.150
Üniversal Prizi
Universal Socket

Kapaklı Kanal Üstü Prizler / Mosaic Sockets with Cover



350.216.160
Kapaklı Şebeke Prizi
Schuko Mosaic Socket with Cover



350.316.160
Kapaklı UPS Prizi
Unischuko Mosaic Socket with Cover

Eklenebilir Prizler / Mountable Sockets

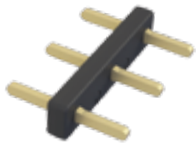

740.061.002
Priz Birleşme Aparatı
Socket's Connector



346.216.160
45° Çift Tırnaklı Şebeke Prizi
45° Schuko Socket

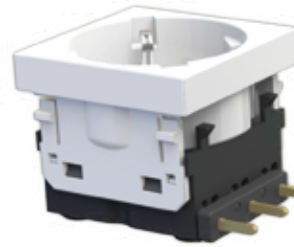

723.000.150
TV Prizi
TV Socket



723.000.300
TV Eekek prizi
TV Male socket









723.000.400
Uydu prizi - F Konnektörlü
SAT Wall socket - F connector



IEC Sockets / IEC Prizleri



724.021.000 GST Dişi Priz / female socket	724.011.000 GST Erkek fiş / male plug	724.020.000 GST Erkek Soket / female socket	724.010.000 GST Erkek Fiş / male plug
			
720.130.150 IEC C13 10A - Tırnaklı / push-in	720.130.160 IEC C13 10A - Vidalı / screwed	720.140.320 IEC C14 10A - Tırnaklı / push-in	720.140.340 IEC C14 10A - Vidalı / screwed
			
720.190.150 IEC C19 16A - Tırnaklı / push-in	720.190.160 IEC C19 16A - Vidalı / screwed	720.200.320 IEC C20 16A - Tırnaklı / push-in	720.240.340 IEC C20 16A - Vidalı / screwed
			
720.130.200 IEC C13 10A - Seyyar / inline	720.190.200 IEC C19 16A - Seyyar / inline	720.140.300 IEC C14 10A - Seyyar / inline	720.200.300 IEC C20 16A - Seyyar / inline
			
720.140.321 IEC C14 10A	720.200.321 IEC C20 16A	720.400.201 2.5m ² socket/soket	
		GST konnektör eski tip M&F GST connector old type M&F	
			

Kapaklar / Covers

708.100.010	708.100.020
Döşeme altı soket kapağı 50x50 mm Faceplate for under floor 50x50 mm	Döşeme altı soket kapağı 50x50 mm Faceplate for under floor 50x50 mm
	

709.100.103	709.100.104	709.200.103	709.200.104
Keystone plastik kapağı Plastic cover for keystone 45x45mm	Keystone plastik kapağı Plastic cover for keystone 22.5x45mm	Plastik kapağı Plastic cover 45x45mm	Plastik kapağı Plastic cover 22.5x45mm
			



710.100.103	710.100.104	710.100.105
Yaylı keystone kapağı Faceplate with shutter 45x45mm	Yaylı keystone kapağı Faceplate with shutter 22.5x45mm	Yaylı keystone kapağı Faceplate with shutter 45x45mm
		





710.100.111	710.100.106	710.100.107
Düz keystone kapağı Flat faceplate 22.5x45mm	Düz keystone kapağı Flat faceplate 45x45mm	Düz keystone kapağı Flat faceplate 45x45mm
		





710.100.108	710.100.109	710.100.110
Yükseltme kapak Lift up faceplate 45x45mm	Yüksek keystone faceplate Lift up faceplate 45x45mm	Yüksek keystone faceplate Lift up faceplate 45x45mm
		



Keystone jack

710.100.350	710.100.360	710.100.332-2/4/6 PIN
CAT5 DATA plug / fişi	CAT6 DATA plug / fişi	Telephone plug / Telefon fişi
		

715.100.030	715.100.050	715.100.060	715.100.061
RJ11/12 CAT3 Telephone	RJ45 CAT5e DATA	RJ45 CAT6 DATA	RJ45 CAT6A DATA
			

715.200.030	715.200.050	715.200.060	715.200.061
RJ11/12 CAT3 Telephone f / f	RJ45 CAT5e DATA f / f	RJ45 CAT6 DATA f / f	RJ45 CAT6A DATA f / f
			

* Daha fazla seçenek için satış temsilcisi ile iletişime geçiniz.







Please contact to sales expert for more variety.

Multimedya Soketler / Multimedia Faceplates

HDMI Faceplates / HDMI Konnektörleri

<p>715.400.001 f / f 90° 22.5x45 mm</p>	<p>715.400.002 f / f 180° 22.5x45 mm</p>	<p>715.400.003 f / f 22.5x45 mm</p>
		
<p>715.400.004 keystone f - f</p>	<p>715.400.005 kablolu 8-10cm / keystone with cable f - f</p>	<p>715.400.008 Kablolu faceplate / faceplate with Cable 45x45 mm</p>
		

USB Faceplates / USB Konnektörleri



<p>715.200.004 f / f 90° 22.5x45 mm</p>	<p>715.200.005 f / f 180° 22.5x45 mm</p>	<p>715.200.006 screw-in 22.5x45 mm</p>
		
<p>715.200.001 keystone f / f</p>	<p>715.200.002 keystone f / f</p>	<p>715.200.003 keystone with cable / kablolu 8-10cm f / f</p>
<p>USB - B</p> 	<p>USB- A</p> 	<p>USB - A</p> 

RAC & STEREO Faceplates / TV & STEREO Konnektörleri

715.500.002	715.500.001	715.600.001
RAC Faceplates screw-in / klemensli 22.5x45 mm	RAC Faceplates screw-in / klemensli 22.5x45 mm	STERRO screw-in 22 5x45 mm
		

VGA Faceplates / VGA Konnektörleri

715.300.001	715.300.002	715.300.004	715.300.005	715.300.007
6+2 screw-in / klemensli 2.5x45 mm	14+2 push-in / klemensli 22.5x45 mm	f / f connectors / konnektörü 180° 22.5x45 mm	15 Klemens Girişli / 15 terminal input	9 Pinli Vga konnektör / Vga connector 9 pin
				

715.300.009	715.300.003
f / f B connectors / konnektörü 45x45 mm	f / f connectors / konnektörü 45x45 mm
	

RAC & STEREO Faceplates / TV & STEREO Konnektörleri

715.700.001	715.600.002
f / f Display port connectors / faceplate konnektörü 45x45 mm	f / f XLR Socket / soket faceplate 45x45 mm
	

USB Şarj / USB Charger



USB Şarj — USB Charger

Beyaz / White	Siyah / Black	Beyaz / White	Siyah / Black	Beyaz / White	Siyah / Black	Beyaz / White	Siyah / Black	Beyaz / White	Siyah / Black
715.100.100	715.100.101	715.100.110	715.100.111	715.200.110	715.200.111	715.200.100	715.200.101	715.200.200	715.200.201
USB type: A/C Max Impulse: 2.1A 45x45mm		USB type: A/A Max Impulse: 2.1A 45x45mm		USB type: A Max Impulse: 2A 22.5x45 mm		USB type: A Max Impulse: 1A 22.5x45 mm		USB type: A Max Impulse: 2.1 A 22.5x45 mm	

ON-OFF Anahtar — ON/OFF Switch

İşıksız / Unlit	İşıklı / Illuminated	İşıksız / Unlit	İşıklı / Illuminated	İşıksız / Unlit	İşıklı / Illuminated
722.225.010	722.225.110	722.045.012	722.045.112	722.045.011	722.045.111
22.5x45mm	10A	45x45mm	16A	45x45mm	2x16A

İşıksız / Unlit	İşıksız / Unlit	İşıklı / Illuminated	İşıklı / Illuminated
722.225.021	722.045.022	722.225.112	722.045.122
22.5x45mm	45x45mm	22.5x45mm	45x45mm

Montaj Aksesuarları
Accessories for Assembly

A-SK1

KANAL SİGORTA KAPAĞI circuit breaker cover
for cable trunking

A-SK2

210, 280 SİGORTA KAPAĞI circuit breaker cover for
210 and 280

A-SR1

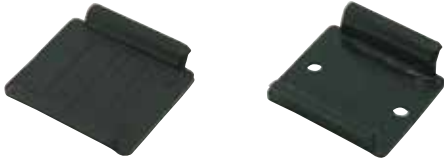
KANAL SİGORTA RAYI circuit breaker support

A-KC1

KABLO GEÇİŞ CONTASI cable gland

Kablolar / Cables

725.315.113

ÇİFT TOPRAKLI FİŞLİ KABLO cable with double
earthed plug3G 1,5 H0VV-F 3 m.
250V
16A
TS.IEC 60884-1

725.325.113

ÇİFT TOPRAKLI FİŞLİ KABLO cable with double
earthed plug3G 2,5 H0VV-F 3 m.
250V
16A
TS.IEC 60884-1

725.310.212

GÜÇ KABLOSU power cable3G 1 H0VV-F 1,8 m.
250V 16A
TS.IEC 60884-1
250V 10A
IEC 320

725.315.123



İNGİLİZ FİŞLİ KABLO cable with british plug3G 1,5 H0VV-F 3 m.
250V
13A
BS 1363-1

IP Koruma Sınıfları / IP Protection Class

IP Değerlerine Göre Koruma Sınıflaması IP Protection Class



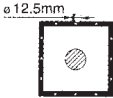
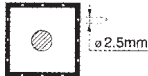
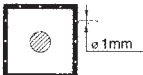

İLK RAKAM: Vücuda karşı koruma

FIRST NUMBER: Protection Against Foreign Substance & Contact

0	Korumasız Unprotected	
1	El ile yaklaşımda Koruma mesafesi 50 mm Foreign Subst. 50 mm	
2	Parmak ile yaklaşımda Koruma mesafesi 12,5 mm Foreign Subst. 12,5 mm	
3	Alet ve kablo ile yaklaşımda Koruma mesafesi 2,5 mm Foreign Subst. 2,5 mm	
4	Alet ve kablo ile yaklaşımda Koruma mesafesi 1 mm Foreign Subst. 1 mm	
5	Toza karşı zarfsız Koruma Dust protected	
6	Toza karşı zarfsız Koruma Dust proof	

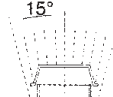
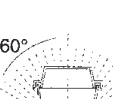
İKİNCİ RAKAM: Suya karşı koruma

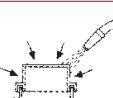
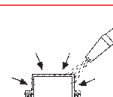
SECOND NUMBER: Protection Against Water

0	Korumasız Unprotected	
1	Düşey su damlasına karşı koruma Vertical water dripping	
2	15° Eğimli Su damlası karşı koruma Water dripping 15° inci	
3	60° Eğimli Püskürtme suya karşı koruma Water spray 60° inci	
4	Her doğrultuda Püskürtme suya karşı koruma Splash water	
5	Her doğrultuda Püskürtme suya karşı koruma Jet-water proof	
6	Bol suda geçici kalma sızdırmazlık Indation	
7	Basınçlı suda Bir süre kalma Immersion	
8	Basınçlı suda Bir süre kalma Submersion	